

# Omnixie Plus

## User manual v2.1.0

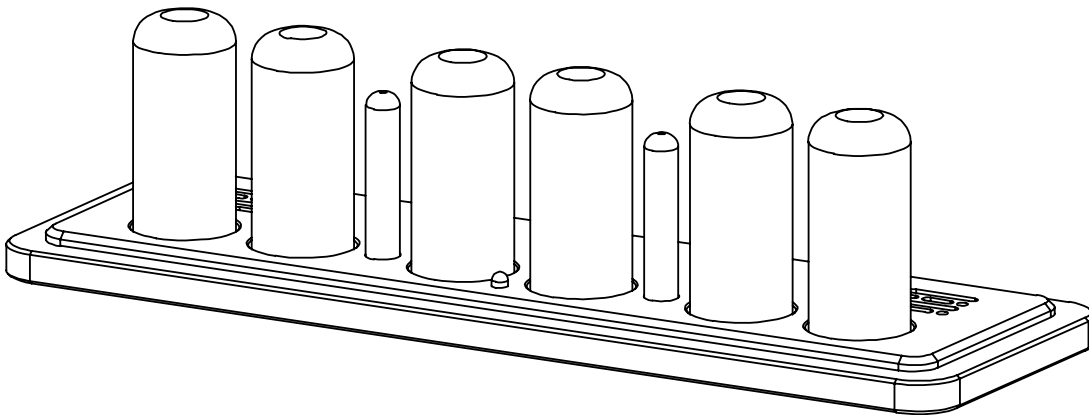

Designer: Yan Zeyuan. China  
Website: [www.omnixie.com](http://www.omnixie.com)  
[www.omnixie.cn](http://www.omnixie.cn)  
E-mail: [yan@omnixie.cn](mailto:yan@omnixie.cn)

---

## Attention

- ◇ Attention: To prevent accidental damage, do not place the Omnixie on an uneven surface.
- ◇ Warning: The Omnixie has an internal high voltage circuit. DO NOT open; DO NOT touch the components while the Omnixie is operating.
- ◇ Warning: In order to ensure normal operation, please use only the included power adapter.
- ◇ Warning: The Omnixie is for indoor use only.
- ◇ Warning: Please keep out of the reach of children.

# Contents

<b>Introduction</b>	
Package Contents.....	5
Appearance.....	6
Dimension.....	7
Technical Specifications.....	8
Features.....	9
IR Remote.....	10
Power Adapter.....	10
<b>Get Ready Before Use</b>	
Install Nixie Tubes.....	11
Plug In Power Cable.....	11
WiFi Status Indicator.....	11
Cleaning.....	11
<b>WiFi Connection</b>	
WiFi Introduction.....	12
WiFi Configuration with iPhone.....	15
Open Dashboard on iPhone.....	17
WiFi Configuration with Android.....	19
Open Dashboard on Android.....	21
WiFi Configuration with Microsoft Windows.....	23
Open Dashboard on Microsoft Windows.....	25
<b>Setup the Omnixie Using the Omnixie Dashboard</b>	
Introduction of the Dashboard.....	27
Set Language of the Dashboard.....	27
WiFi Setup.....	28
System Status.....	29
NTP Setup.....	30
General Setup.....	31
Display Setup.....	32
Setup Alarms.....	33
Advanced Setup.....	34
Upgrade Firmware.....	35

## Setup the Omnixie with IR Remote

Power On/Off.....	37
Set Brightness.....	37
Talking Clock.....	38
Set Volume.....	38
Display Time.....	39
Set Time.....	40
Display Date.....	41
Set Date.....	42
Display Alarms.....	43
Set Alarms.....	44
Set Auto On/Off Time.....	45
System Menu.....	46

## Menu Setup

Menu 1 Set Time Format.....	47
Menu 2 Set Date Format.....	47
Menu 3 Set Interval of Time Display.....	47
Menu 4 Set Interval of Date Display.....	48
Menu 5 Set Leading Zero.....	48
Menu 6 Set Switching Effects of the Digits.....	48
Menu 7 Set Switching Speed of the Digits.....	49
Menu 8 Set Colons Animation Effects.....	49
Menu 9 Set Alarm Sound Tone.....	49
Menu 10 Set Alarm Volume.....	50
Menu 11 Set Talking Clock Language.....	50
Menu 12 Set Interval of Talking Clock.....	50
Menu 13 Set Backlight Effects.....	51
Menu 14 Set Backlight Color.....	51
Menu 15 Set Interval of CP Prevention.....	51
Menu 16 Set Running Time of CP Prevention.....	52
Menu 17 Display IP Address.....	52
Menu 18 Display Firmware Version.....	52

## Reference

Special Remarks.....	52
----------------------	----

# Package Contents

Before getting started, please check the contents of the package. If any parts are missing, please contact the seller. Package consists of the following items:

---

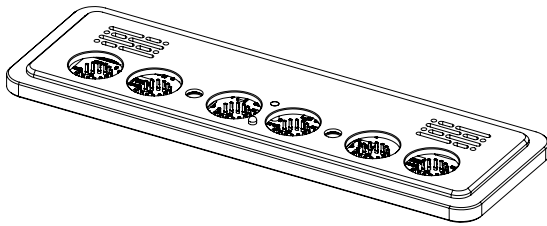

Omnixie Plus Clock base

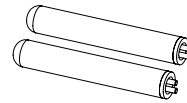

Colon tubes

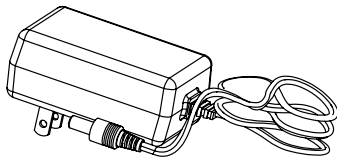

Power adapter

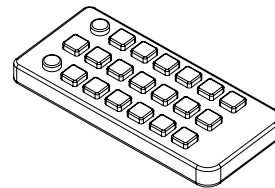

IR Remote Controller

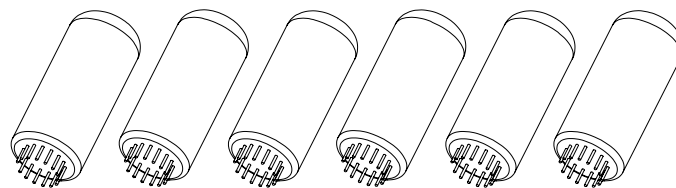

Nixie Tubes (optional)



- The included power adapter can handle high current and therefore allow normal operation. DO NOT use other type of power adapter.

# Appearance

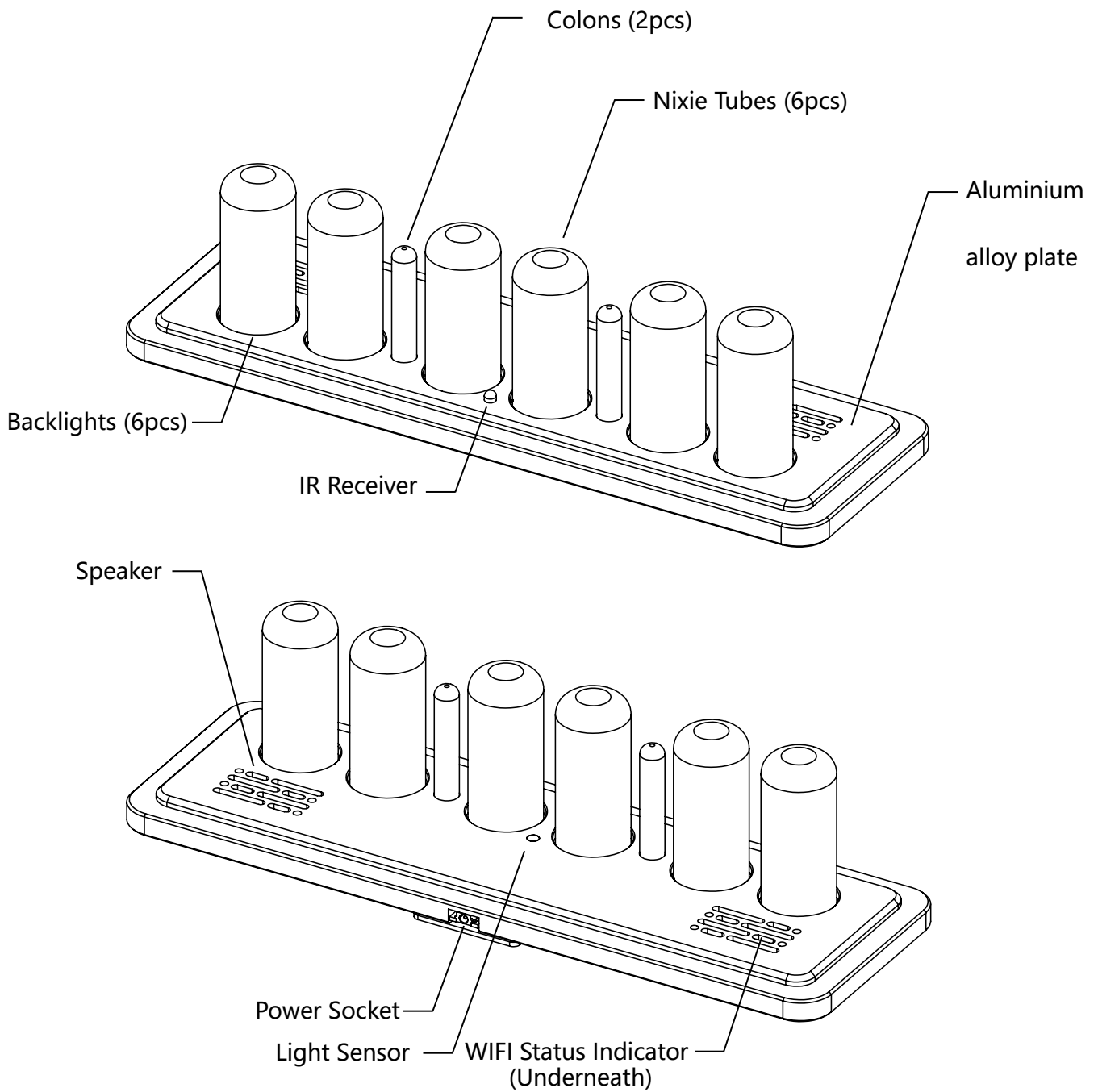

- Over three tube variations were designed for the Omnixie, each type of tube has a different appearance.

# Dimension

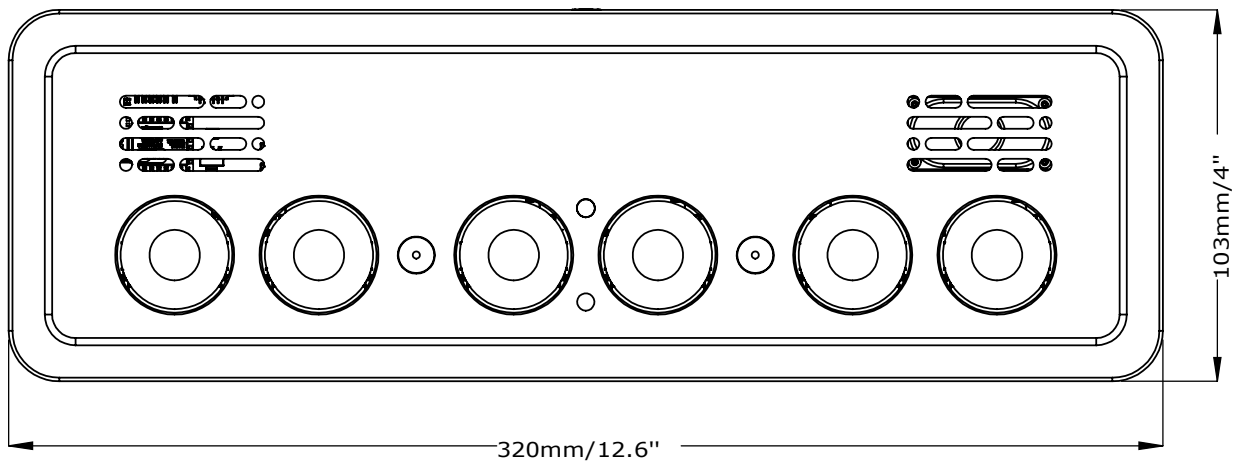
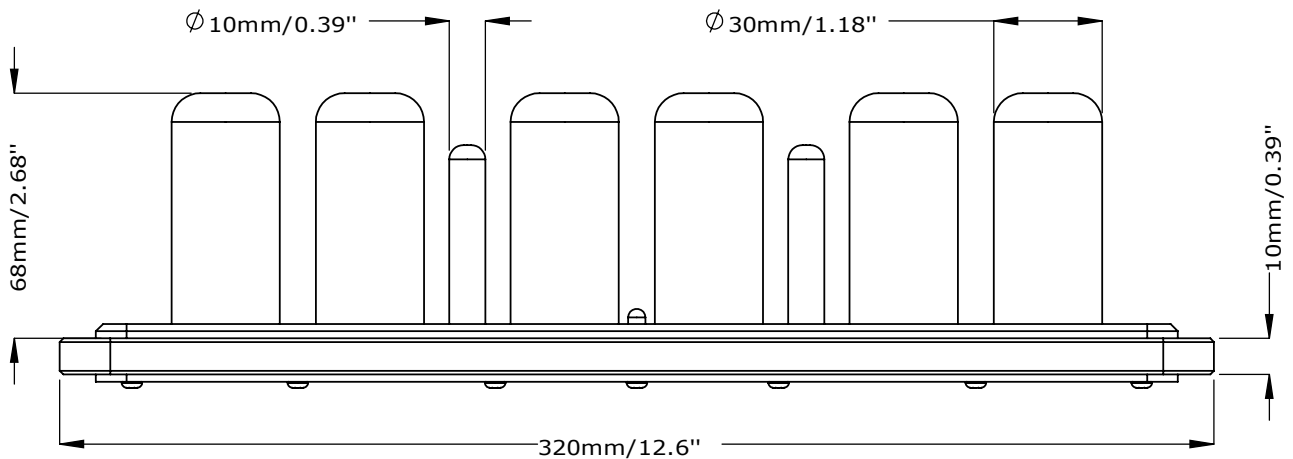

- Different types of Nixie tubes have different heights. (The dimension listed above is for your reference only)

# Technical Specifications

Name	Specifications
Nixie Tubes Omnixie Plus IN	IN-18 (Rovno made in Soviet Union)
Omnixie Plus ZM	ZM1040/ZM1042(Mullard/Philips/Tesla/Siemens/Valvo.Ultron)
Power input	DC12V 600mA(Max) / DC3.5-1.35
WIFI	IEEE 802.11 b/g/n
Frequency range	2.412GHz – 2.484GHz
Antenna	Built-in PCB board antenna
Dimension	Base 320mm(L) x 103mm(W) x 10mm(H) Height of Nixie tubes 62mm – 71mm(Based on tube types)
Material of housing	Aluminum panel Hardwood frame Stainless steel base plate.
Operation temperature	0°C - 60°C
Weight	~9120g (Only the Omnixie clock) ~1100g (Complete packaging)



- The Omnixie will be compatible with additional Nixie tubes, please visit our website for more information.



# Features

Name	Description
Swappable Nixie tubes and colon tubes	Compatible with dozens of different types of Nixie tubes, gold-plated connectors ensure stable and reliable connection with easy tube replacement.
WIFI synchronization	Built-in WIFI module, connect to router automatically and sync date and time from NTP server (NTP time accuracy can reach 1-50ms) after initial setup, never worry about the accuracy, leap year, leap seconds. Daylight saving time can be automatically adjusted. High-precision network time please refer to <a href="https://time.is">https://time.is</a>
Web configuration (Support iOS, Android, Mac OS, Windows)	Built-in web server, open any web browser to access the interface page (Dashboard) to configuration of all Omnixie features including WIFI parameter settings, NTP settings, system status, general settings, display settings, alarm settings and firmware upgrade.
DHCP 、 mDNS 、 SSDP support	Support DHCP settings for external network access, supports mDNS for browser domain name access (no need to remember device IP address), supports SSDP for fast network discovery.
OTA firmware upgrade	The system firmware can be upgraded directly through the Web interface without any special equipment.
Support GMT setting	Supports GMT time zone setting. The system will automatically convert the local date and time according to the GMT time zone settings.
Support DST setting	Supports DST settings. Customize the start and end dates for daylight saving time to adapt to different countries daylight saving time rules.
Brightness adjustable	8 brightness levels for Nixie tubes and backlights, which can also be automatically adjusted according to ambient light conditions (to allow sleep at night).
Talking clock	Intelligent speech system in English, Chinese Mandarin, Japanese and German. The interval and alarm music are user customizable.
Alarm	Four individually configurable alarm clocks, supports snooze function. (weekend activation optional)
Music key tone and alarm	Variety of key tone sound effects for easy setting confirmation. 12 kinds of alarm music, the alarm volume can be set independently.
Switch automatically On/Off	On and Off time can be set for longer tube lifetime.
IR remote	IR remote controller operation.
Volume adjustable	8 volume levels. Independent Alarm volume, mute does not affect the alarm sound.
Digits transition effects	1. Normal 2. Fade in-out 3. Crossfading 4. Slot machine.
Transition speed adjustable	Ten speeds available for the transition.
Colons effects	1. Fade in-out 2. Blinking 3. Always on 4. Always off
Background light effects	1. Always on 2. Fade in-out 3. Always off
Background light color scheme	15 types of background light color scheme can be configured.

# IR Remote

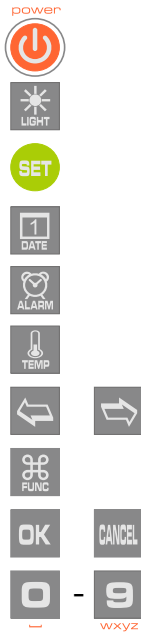

Power	Power ON/OFF
LIGHT	Set Brightness
SET	Enter setup
DATE	Display date
ALARM	Display alarm
TEMP	--NOT IN USE--
LEFT/RIGHT	Move cursor position
FUNC	Enter menu
OK/CANCEL	Save/Abort
NUMBER	Enter numbers



- The IR remote uses (1) CR2025 cell. Transportation rules may not permit shipment with lithium battery installed. Please insert battery or remove the protective insulator to operate.

# Power Adapter

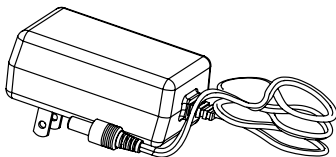

- Input: 100-240VAC, ~180mA, 50/60Hz.
- Standard DC3.5/1.35 output.
- Output DC 12V, Max 1A.



- In order to insure proper operation, only use the supplied power adapter.

# Get Ready Before Use

## Install Nixie tubes (Skip this section if Nixie tubes are installed)

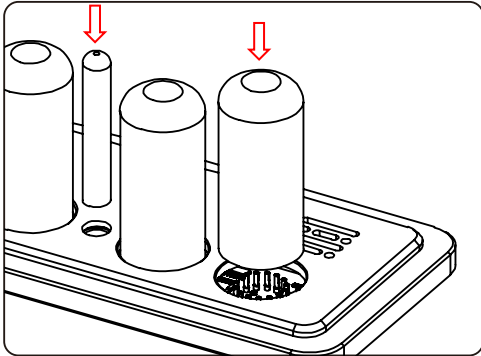

- Face the digits of Nixie tube, align the pins with the sockets and gently insert the tube.
- Adjust the vertical angle of the Nixie tubes after all tubes are inserted.
- If a tube cannot be easily inserted, please check whether the pins are misaligned or bent.
- Face the neons of colon tube, align the pins with the sockets and insert.

## Plug in Power Cable

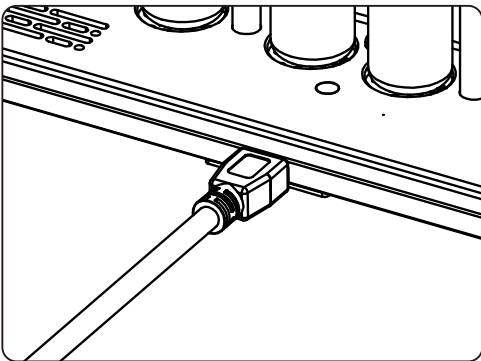

- Plug the power plug into the socket on the back of the Omnixie to turn on the power.
- The Omnixie will start working immediately after power is applied.

## WiFi Status Indicator

The color of Omnixie's WiFi status indicates the current WiFi link status with the following color information:

Color	Status
Red	WiFi router not connected, waiting for configuration.
Yellow	WiFi connected, but the NTP server is not connected.
Green	WiFi connected, and the NTP server is connected.

## Cleaning

Consider the notes below before cleaning the Omnixie.

- Please power off and disconnect power before cleaning.
- Do not use any cleaning agent or wet wiper.
- We suggest use soft cloth or brush to avoid scratching the housing finish.

# WiFi Introduction

The Omnixie can connect to routers via WiFi and access NTP time servers to get accurate network time (NTP servers are located all over the world and choose the fastest connected server based on your location). Additionally, a phone or computer can use the same WiFi connection to set all features of the Omnixie.

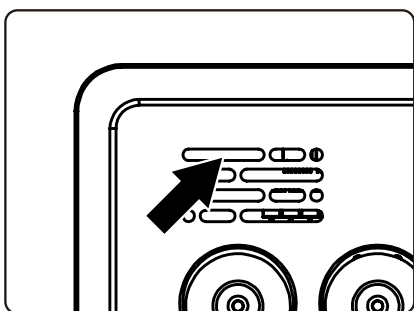
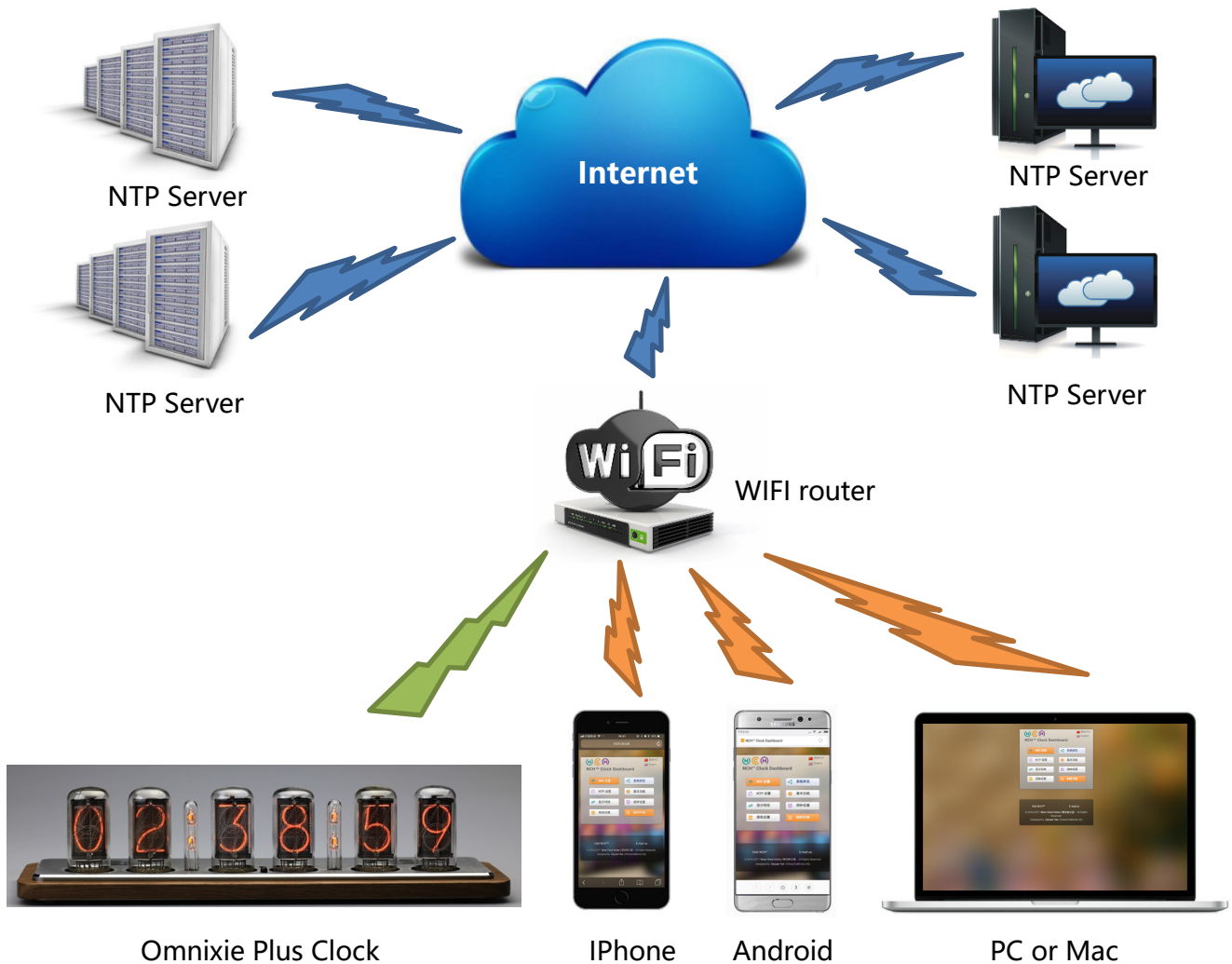

- For the first connection, about 10 seconds after the Omnixie is powered on, the WIFI status indicator will light up in red to indicate that the Omnixie WIFI is not connected to any network and is waiting for configuration. At this point you can use any of the following methods to connect and configure the WIFI network.

## WiFi Introduction

---

- The Omnixie needs to be set to use your home network and requires a “one time” setup.
- On first power-up, the clock creates a WiFi hotspot for the initial configuration.
- On your phone or PC: Go to the WiFi settings and look for an SSID like: Omnixie\_xxxxxx. This is your Omnixie clock.
- Temporarily connect to the clock WiFi SSID and a configuration window should open, or simply browse to <http://192.168.4.1>
- Teach your Omnixie to connect and use your own WiFi network by selecting your home SSID and providing the network password.
- When completed, the Omnixie will reboot and automatically connect to your WiFi.
- Your phone or PC will automatically reconnect back to your home network.
- Omnixie configuration will now use your WiFi network. Use your phone or PC browser to view your Omnixie for complete clock configuration information. Detailed steps for Android, iOS and Windows PC follow.

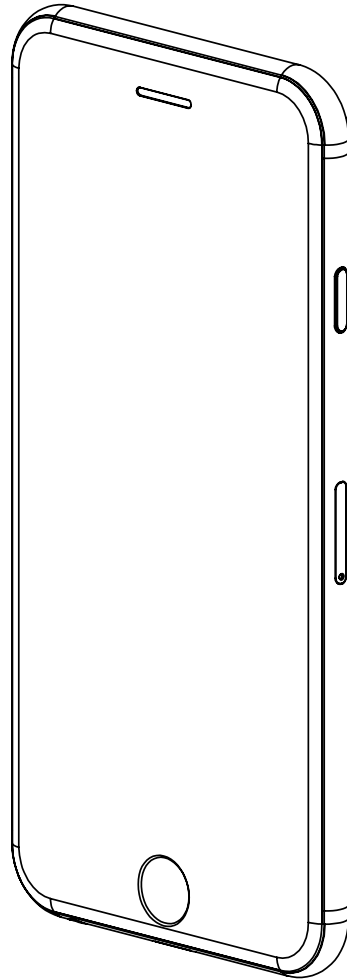

## WiFi Configuration with iPhone

Other iOS devices can refer to this method.

---

# iPhone

## WiFi Configuration with iPhone

Open the **Settings**->**WLAN**, turn on **WLAN**, select Omnixie\_xxxxxx (xxx is a serial # of your clock) in the list. After the network is connected, the WiFi configuration interface will pop up automatically and start to scan the available WiFi networks as shown in the following figure:

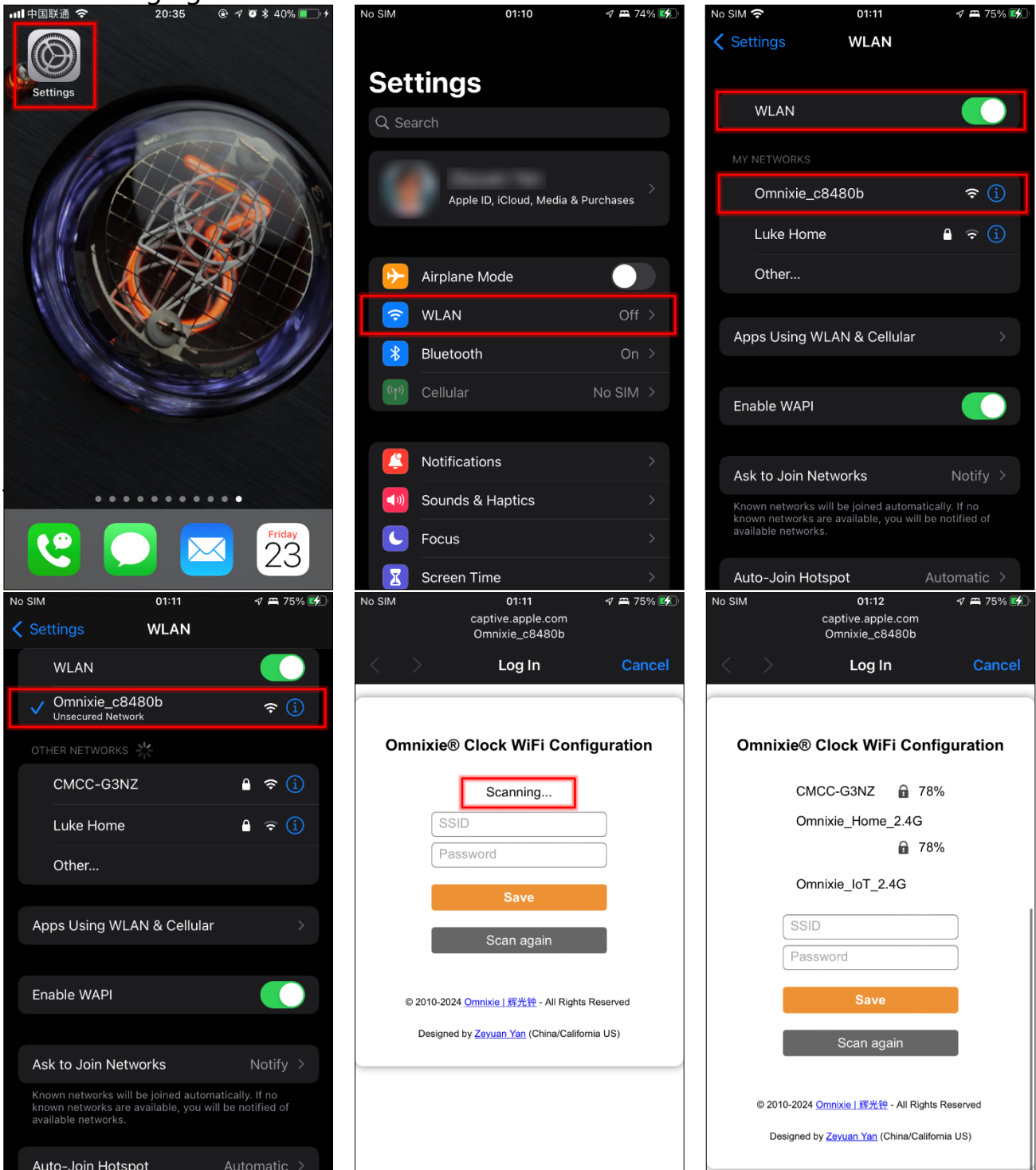

## WiFi Connection

After scanning, all nearby available WiFi networks will display, click the WiFi name and enter the password, then click **Save** button to save the configuration. If no nearby WiFi networks are displayed, please click **Scan again** button to rescan.

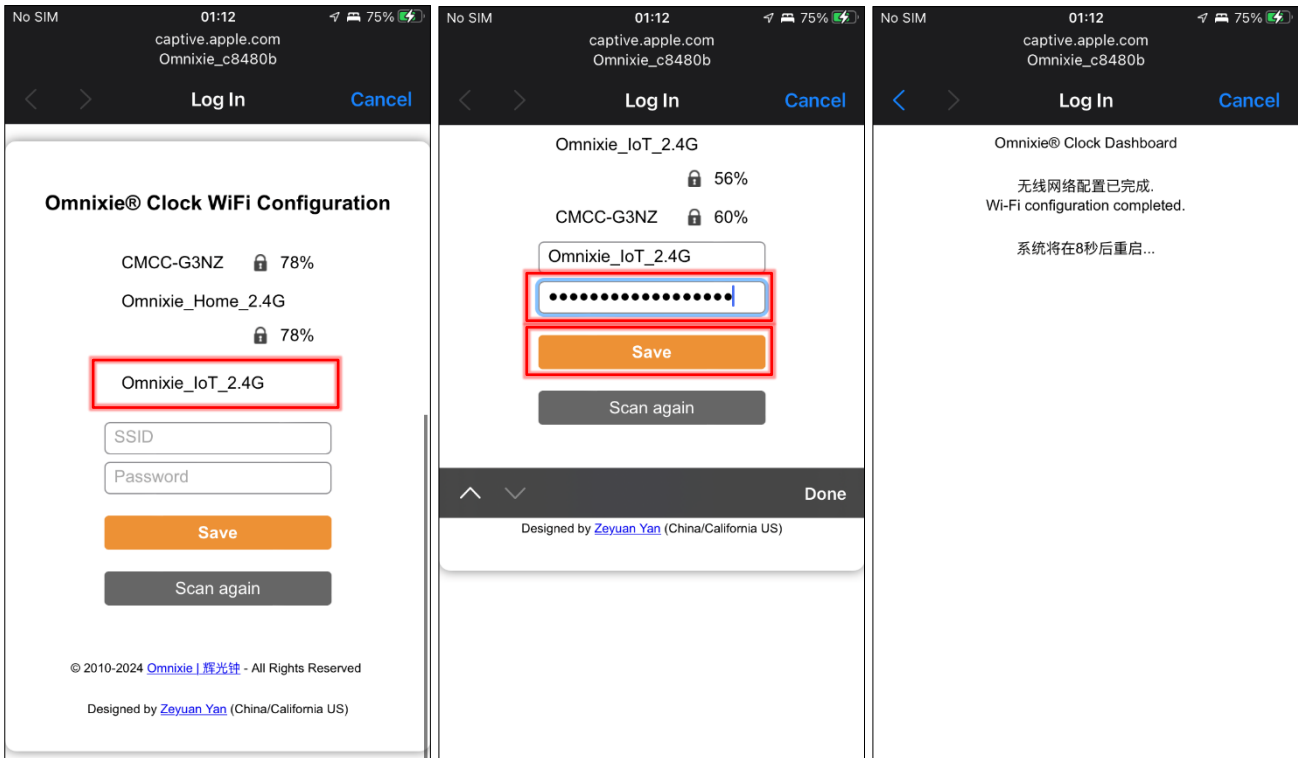

After the WiFi configuration is completed, The Omnixie will reboot and connect to the WiFi automatically. If the connection is successful, the WiFi status indicator will light **yellow** or **green**. If WiFi status indicator still red after rebooting, it indicates that the WiFi password just entered is incorrect, please select again to make settings.

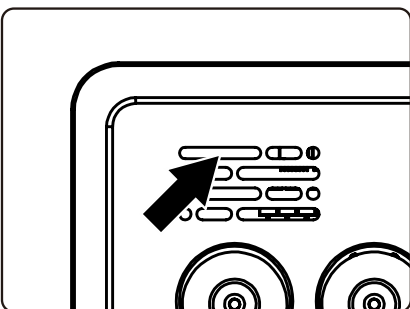

- Omnixie`s network name starts with Omnixie followed by 6-digit identifier.
- For more information of colors of WIFI status indicator, please refer to **Get Ready Before Use-> WIFI Status Indicator**.
- To reset WIFI settings please refer to **Setup the Omnixie using the Omnixie Dashboard -> Advanced Setup**.



## Open Dashboard with iPhone

**Method one:** Open **Safari**, type **omnixie.local** to open Dashboard.

**Method two:** After open Dashboard, click **MENU** button below, click **Add to Home Screen** button, then you can open Dashboard on the phone desktop as an App.

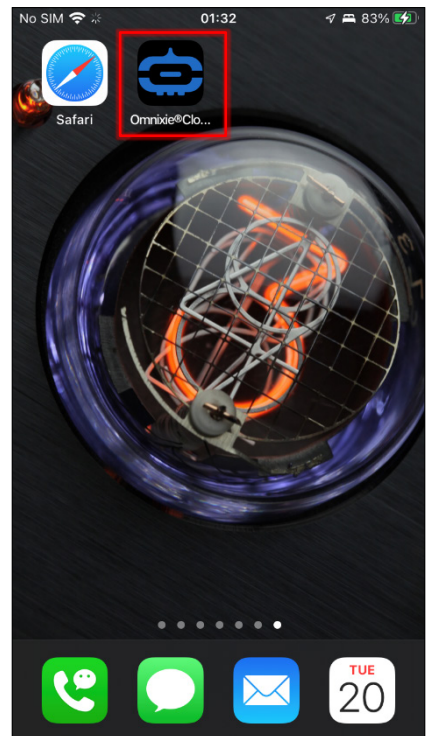
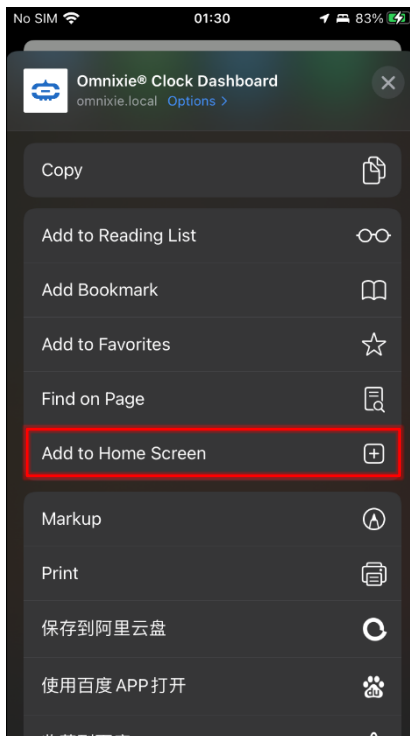
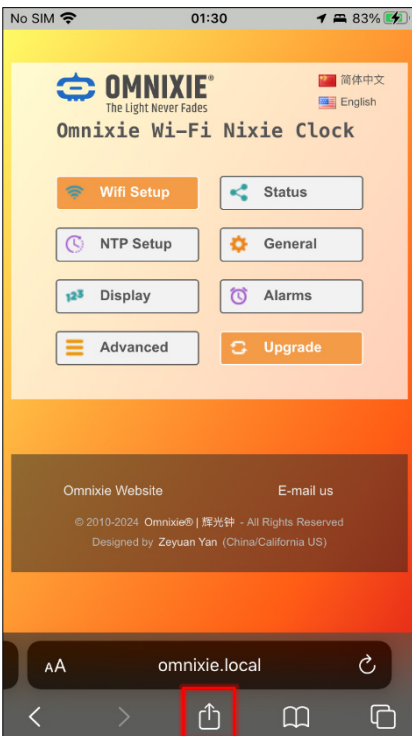
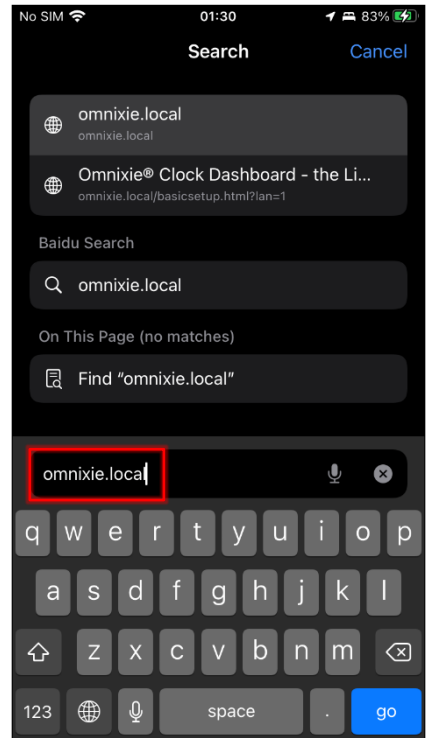
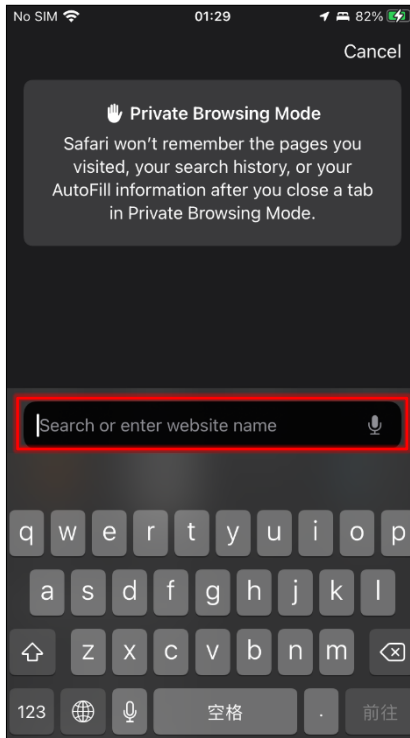
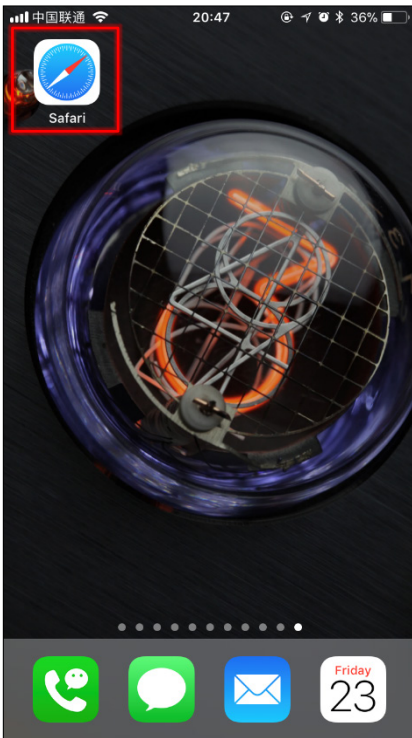

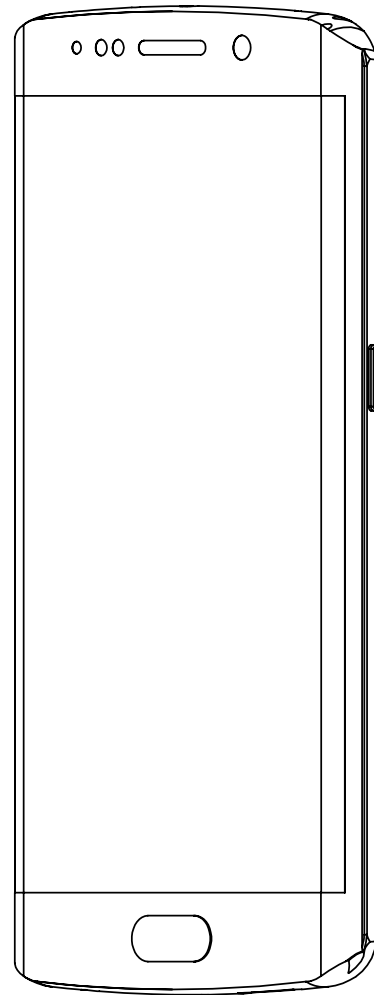

## WiFi Configuration with Android

---

# Android

## WiFi Configuration with Android

Open the **Settings->WLAN**, enable **WLAN**, select Omnixie\_xxxxxx in the list. After network is connected, the WiFi configuration interface will pop up automatically and start to scan the available WiFi networks as shown in the following figure:

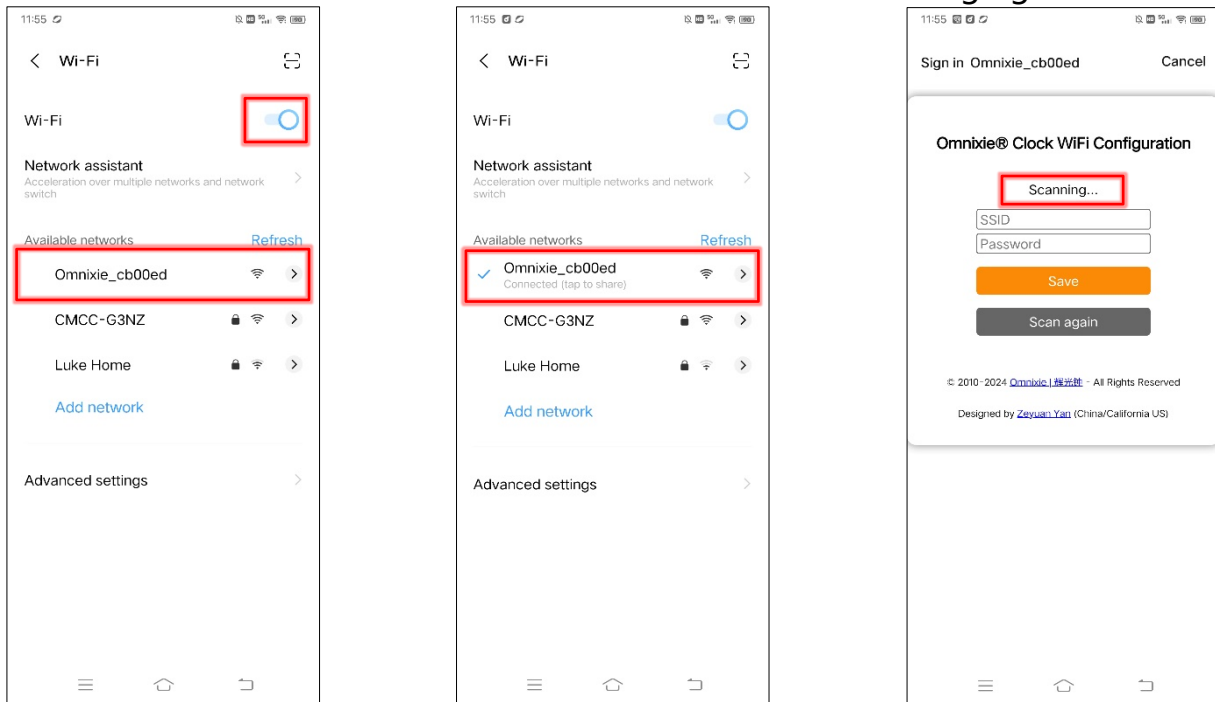

If WiFi configuration interface does not pop up automatically, please open browser and type **192.168.4.1** to open WiFi configuration interface.

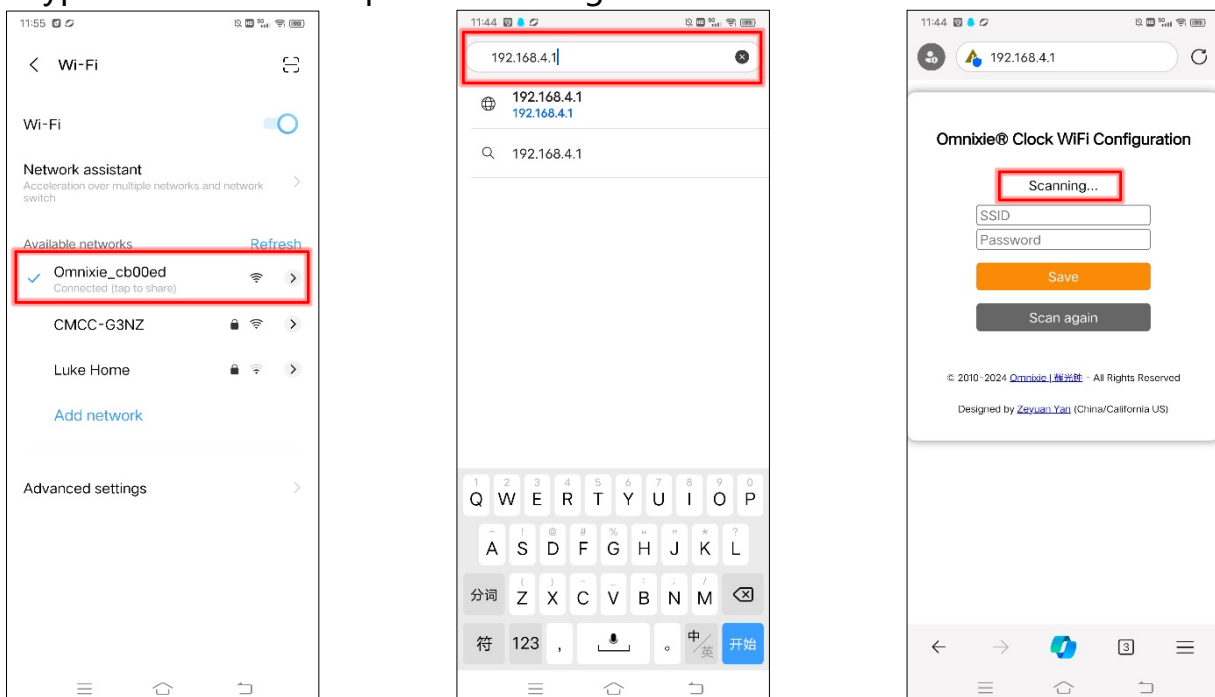

## WiFi Connection

After scanning, all nearby available WiFi networks will display, click the WiFi name and enter the password, then click **Save** button to save the configuration. If no nearby WiFi networks are displayed, please click **Scan again** button to rescan.

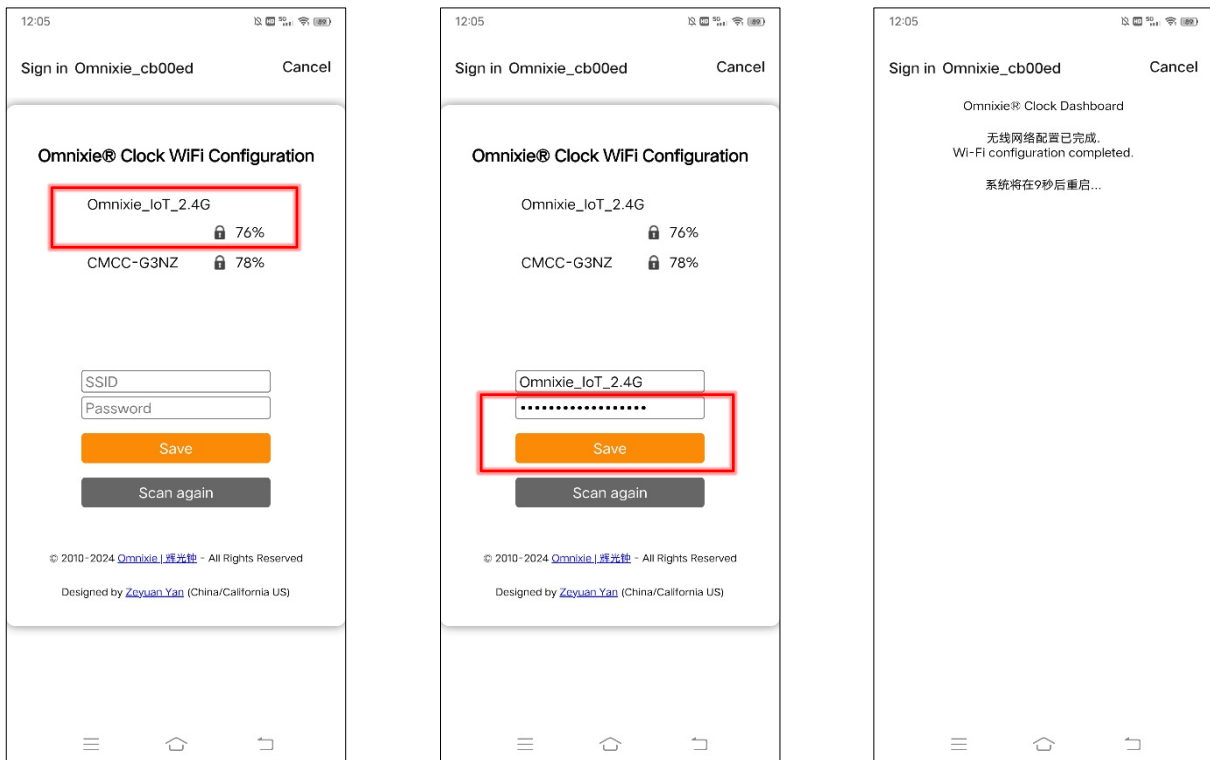

After the WiFi configuration is completed, The Omnixie will reboot and connect to the WiFi automatically. If the connection is successful, the WiFi status indicator will light **yellow** or **green**. If WiFi status indicator still red after rebooting, it indicates that the WiFi password just entered is incorrect, please select again to make settings.

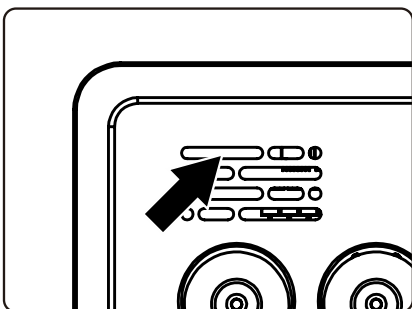

- Omnixie`s network name starts with Omnixie followed by 6-digit identifier.
- For more information of colors of WIFI status indicator, please refer to **Get Ready Before Use-> WIFI Status Indicator**.
- To reset WIFI settings please refer to **Setup the Omnixie using the Omnixie Dashboard -> Advanced Setup**.

## Open Dashboard on Android

Please use the IR remote controller to check the Menu 17 for IP address of the clock (press FUNC key, LEFT key, LEFT key, and OK key in sequence), then input the IP address on your web browser, the Omnixie Clock Dashboard shows up.

After open Dashboard, click **menu** button, click **Tools** button, click **Add shortcut**, click **OK**, then you can open Dashboard on the phone desktop as an App

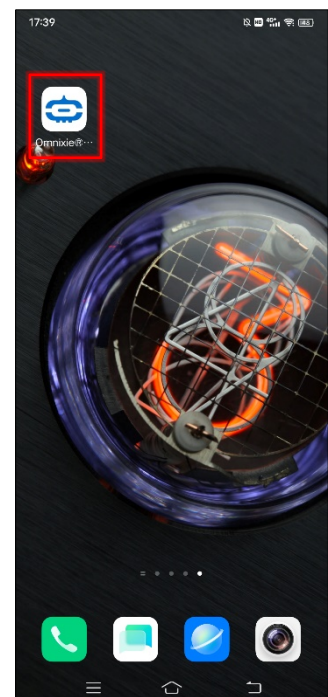
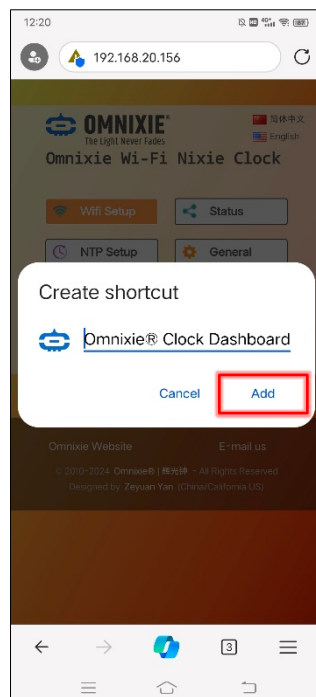
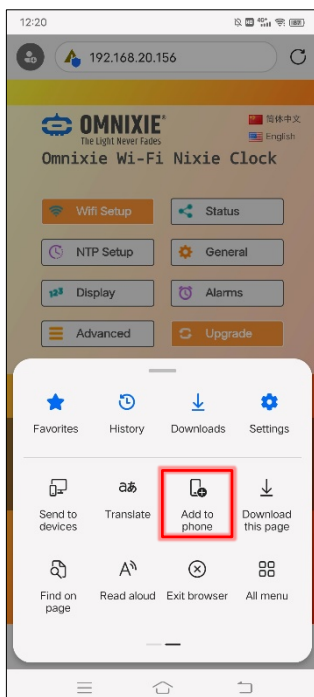
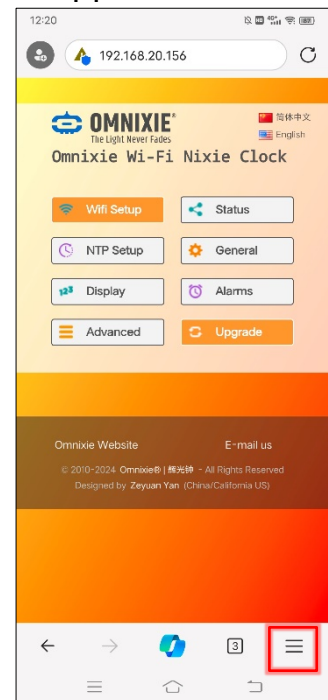
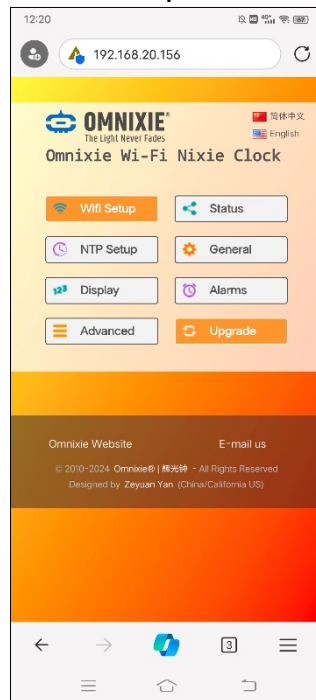



WiFi Configuration with Windows

---

# Windows

## WiFi Configuration with Microsoft Windows

Open the **Start->Settings->Network and Internet->WLAN** using a computer with Windows 10 installed, then select the network **Omnixie\_xxxxxx** in the **WLAN list** on the right. Waiting for the network connection, WiFi configuration page will pop up automatically and start scanning available WiFi networks. If the WiFi configuration interface does not pop up automatically, please open any browser and enter **192.168.4.1** to open the WiFi configuration interface as shown below:

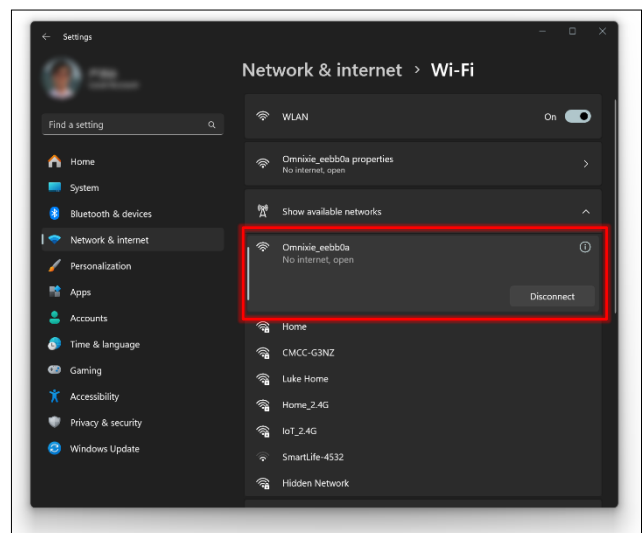
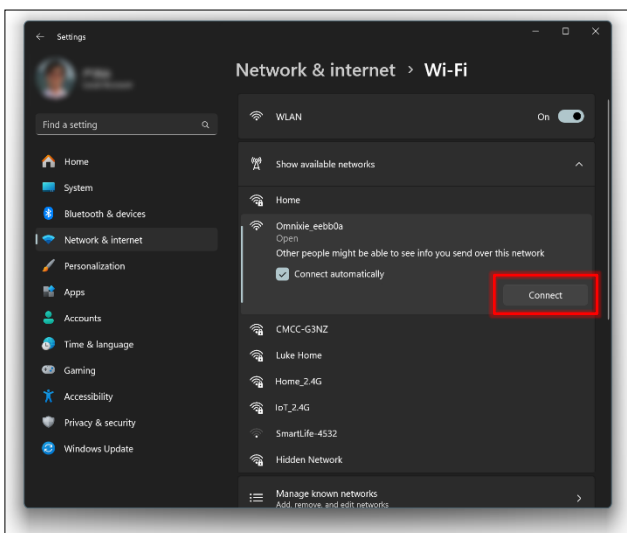
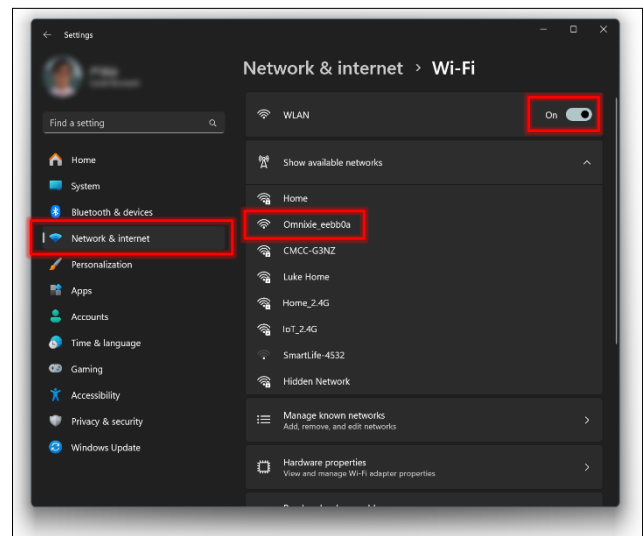
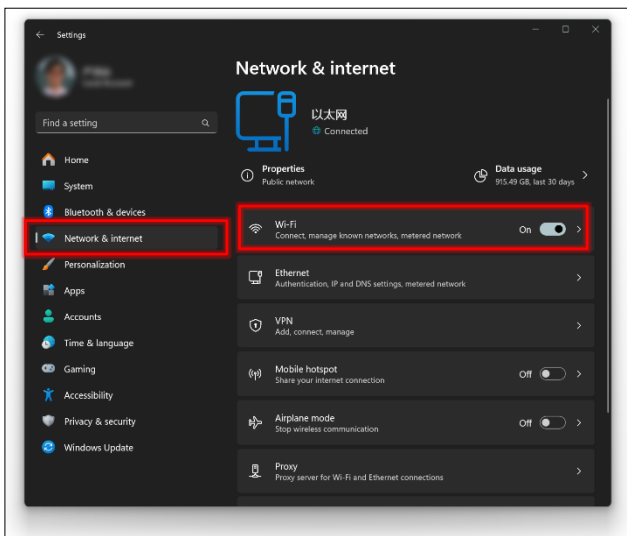

- Omnixie`s network name starts with Omnixie followed by 6-digit identifier.

# WiFi Connection

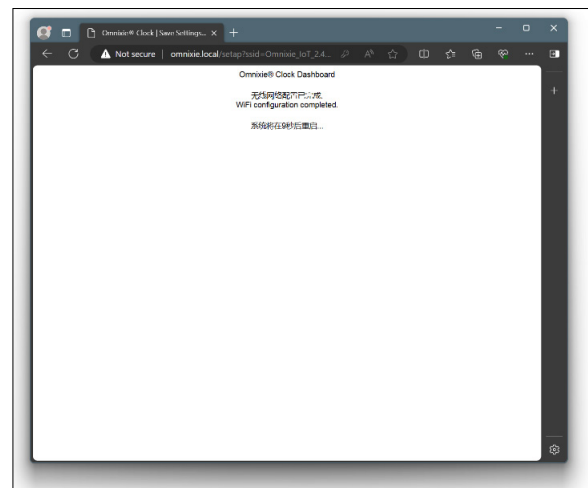
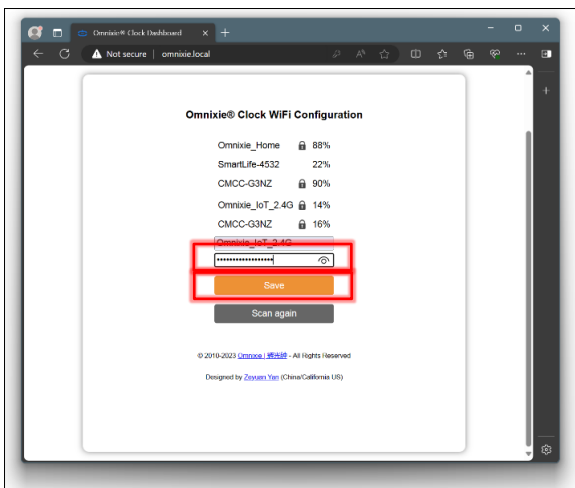
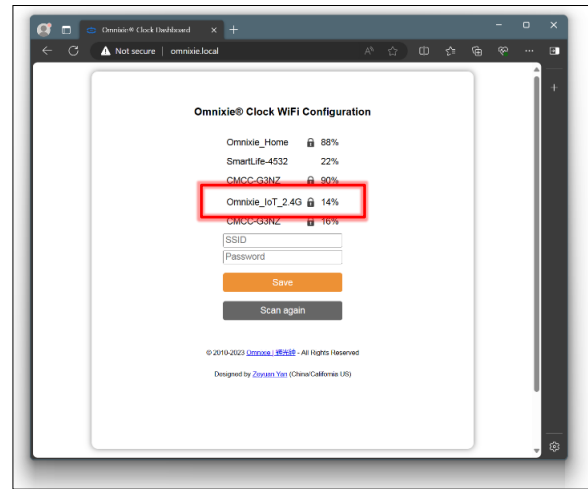
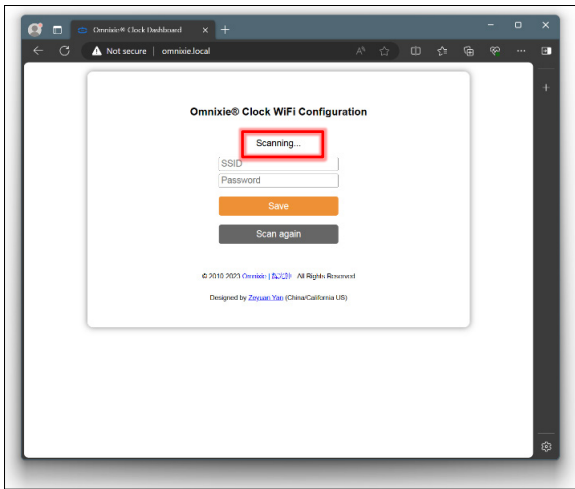

After the WiFi configuration is completed, The Omnixie Will reboot and connect to the WiFi automatically. If the connection is successful, the WiFi status indicator will light **yellow** or **green**. If WiFi status indicator still red after rebooting, it indicates that the WiFi password just entered is incorrect, please select again to make settings.

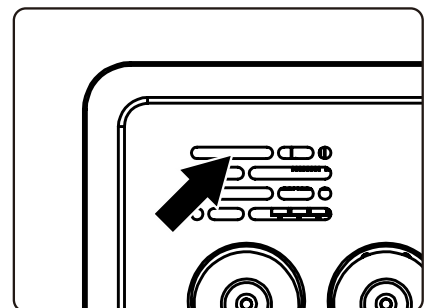

- Omnixie`s network name starts with Omnixie followed by 6-digit identifier.
- For more information of colors of WIFI status indicator, please refer to **Get Ready Before Use-> WIFI Status Indicator**.
- To reset WIFI settings please refer to **Setup the Omnixie using the Omnixie Dashboard -> Advanced Setup**.



### Open Dashboard on Microsoft Windows

**Method one:** Open the browser, enter **omnixie.local** to open the Omnixie dashboard.

**Method two:** Open the **Network**, in the **Home Automation** category will see the Omnixie's icon, double-click the icon to open the Omnixie Dashboard. You can also right-click the icon to see the Omnixie device properties. You can also set the page address as a shortcut on the desktop.

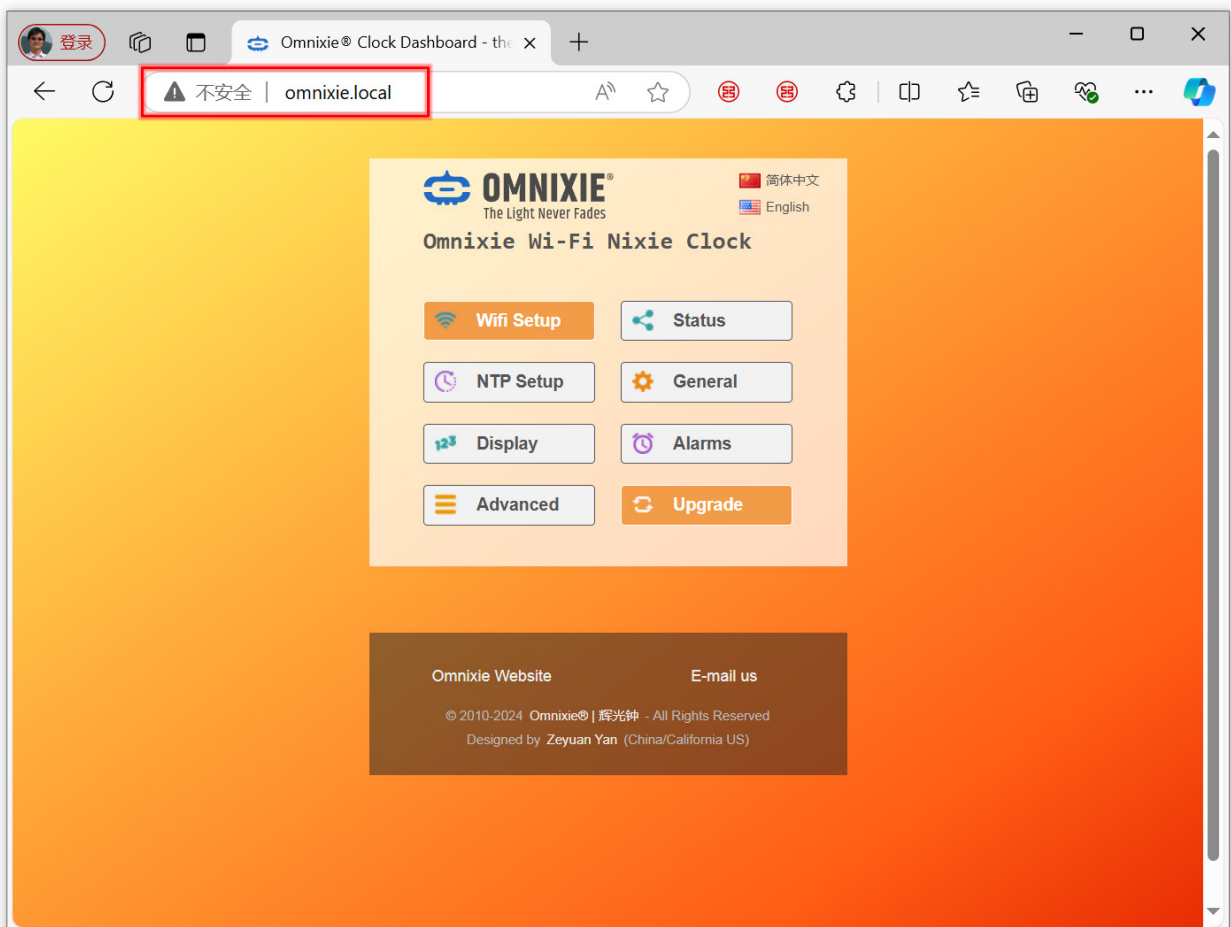

Setup the Omnixie using the

Omnixie Dashboard

---

Omnixie Clock Dashboard

# Set the Omnixie using the Dashboard

## Introduction of the Dashboard

The Dashboard is an interface for remote control and operation of the Omnixie, it includes eight functional modules: **WiFi Setup, System Status, NTP Setup, General Setup, Display Setup, Set Alarms, Advanced Setup, Upgrade Firmware.**

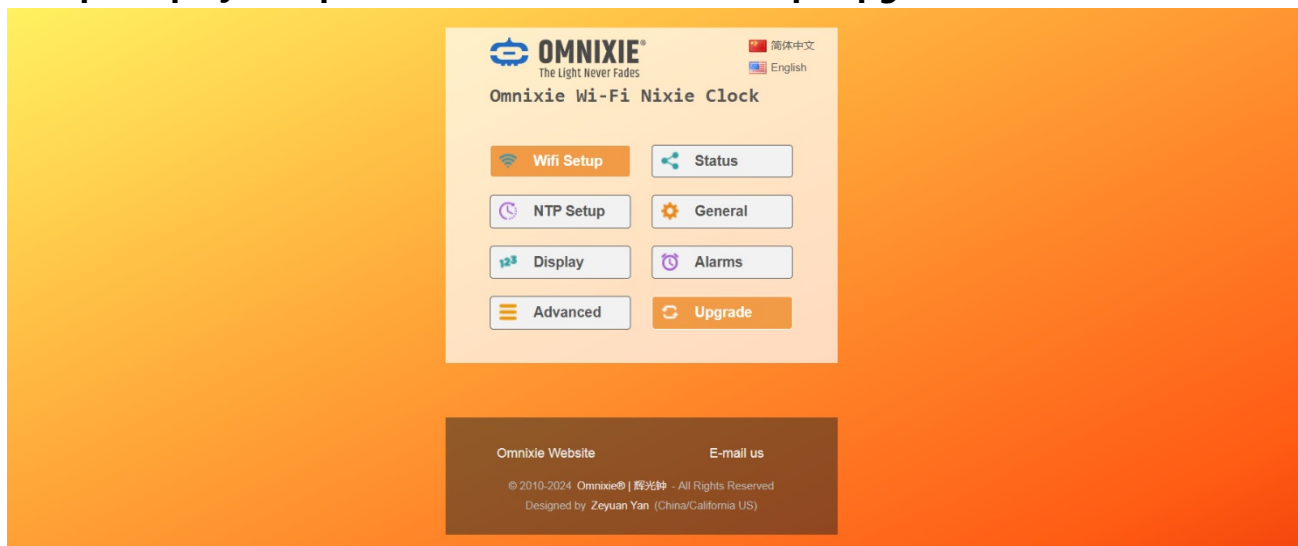

## Set Language of the Dashboard

Click the language button in the upper right corner to switch Dashboard language as shown below:

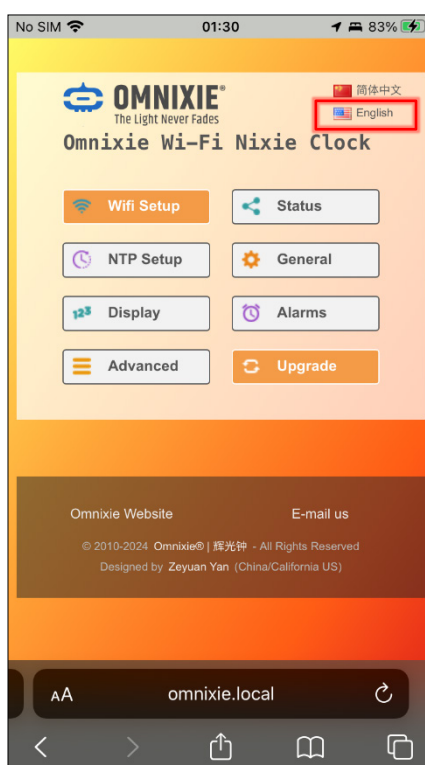

# Setup the Omnixie using the Omnixie Dashboard

## WiFi Setup

WiFi network parameter setting.

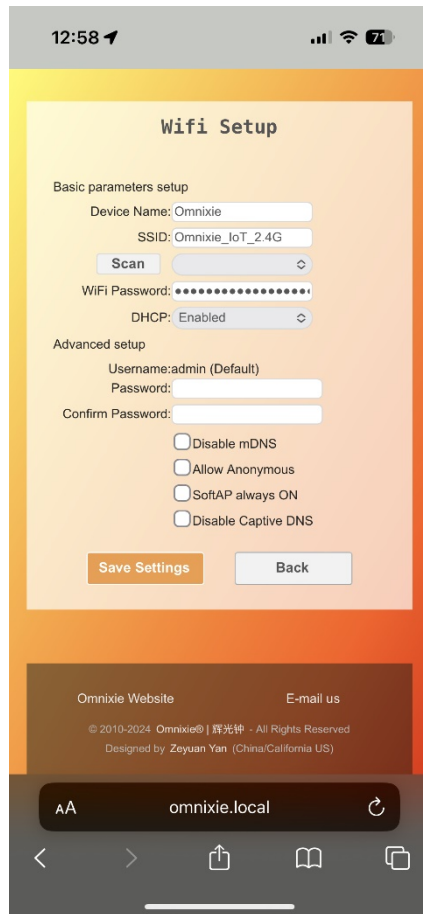

Name	Option	Description
Device Name		The default is Omnixie, network name of the Omnixie.
SSID		The name of the connected network, this is usually the SSID name of the connected router.
Scan		Click Scan button and select the name in the list if you want to connect a different router.
WiFi Password		The password of the network.
DHCP	Enabled Disabled	Default
Username		admin, cannot be changed.
Password		Access password for the Omnixie Dashboard.
Confirm Password		Repeat password.
Disable mDNS		Multicast DNS. (Advanced network settings)
Allow Anonymous		(Advanced network settings)
SoftAP always ON		(Advanced network settings)
Disable Captive DNS		(Advanced network settings)



- “Advanced network settings” items usually do not need to be set.

# Setup the Omnixie using the Omnixie Dashboard

## System Status

View operating parameters of the Omnixie system.

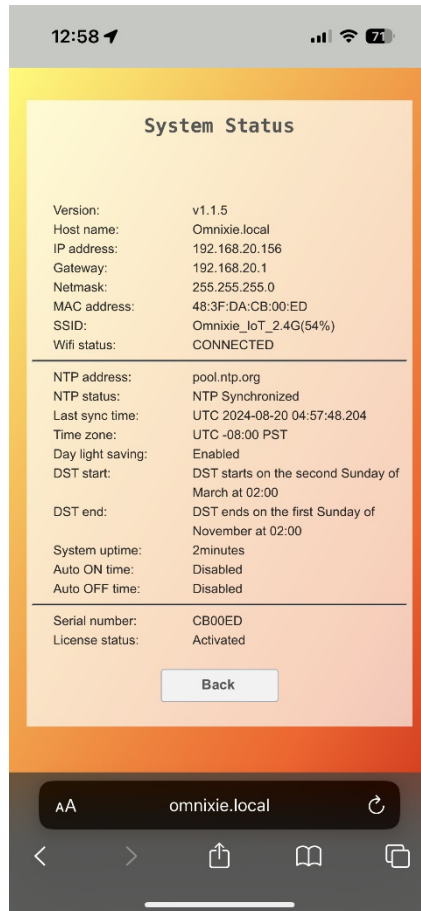

Name	Description
Version	System version
Host name	Configurable
IP address	Configurable
Gateway	Configurable
Net mask	Configurable
MAC address	Unique
SSID	Configurable
WiFi status	Connect status
NTP address	Configurable
NTP status	Connect status
Last sync time	The latest time of sync with NTP
Time zone	Configurable
Day light saving	Configurable
DST start	Configurable
DST end	Configurable
System uptime	System uptime from power up
Auto ON time	Configurable
Auto OFF time	Configurable
Serial number	Unique
License status	Software license

# Setup the Omnixie using the Omnixie Dashboard

## NTP Setup

NTP parameters setting.

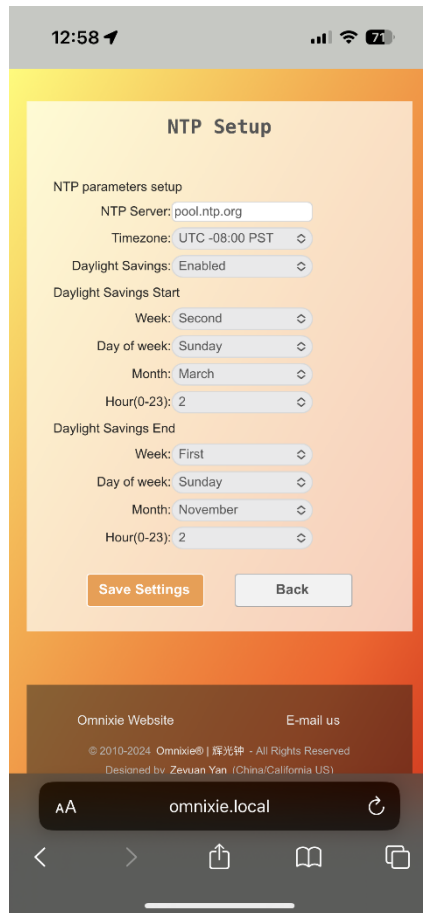

Name	Option	Description
NTP Server	Default pool.ntp.org	is a commonly used NTP server pool.
Time zone	UTC+ 14:00 – UTC-11:00	Default UTC +08:00 CST
Daylight Savings	Enabled	
	Disabled	Default
Week of DST Start	First, Second, Third, Fourth, Last	Default Second
Day of week of DST Start	Sunday – Saturday	Default Sunday
Month of DST Start	January – December	Default March
Hour of DST Start	0 – 23	Default 2
Week of DST End	First, Second, Third, Fourth, Last	Default First
Day of week of DST End	Sunday – Saturday	Default Sunday
Month of DST End	January – December	Default November
Hour of DST End	0 – 23	Default 2



- Please set the time zone correctly, Omnixie will automatically convert the local date and time according to UTC time.

# Setup the Omnixie using the Omnixie Dashboard

## General Setup

Set the basic function parameters of the Omnixie.

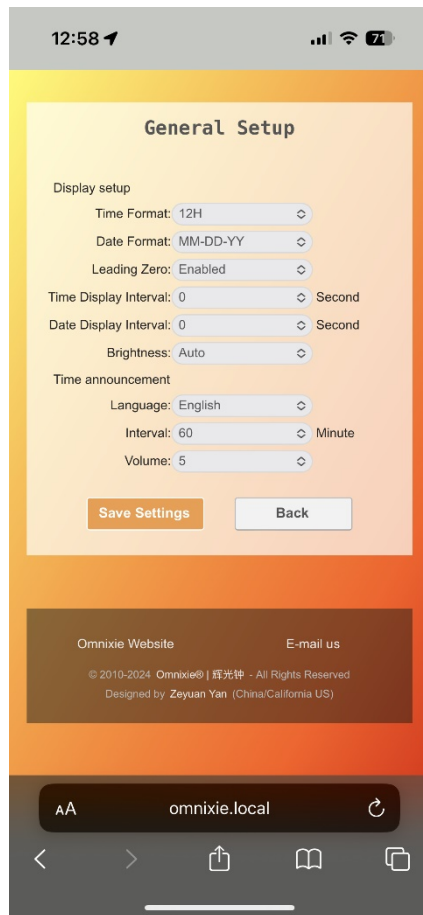

Name	Option	Description
Time Format	24H	Default
	12H	
Date Format	YY-MM-DD	Default
	YY-DD-MM	
	DD-MM-YY	
	MM-DD-YY	
Leading Zero	Enabled	Default
	Disabled	
Time Display Interval	0 - 60 sec	Default 0 sec
Date Display Interval	0 - 60 sec	Default 0 sec
Brightness	Auto	Default
	1(Darkest)-8(Brightest)	
Language	中文普通话(Chinese mandarin)	Default
	English	
	日本語 (Japanese)	
	Deutsch	
Interval	Disable	
	1.2.3.5.10.15.20.30.60 Min	Default 60 Min
Volume	Mute	
	1(Min) – 8(Max)	Default 5

# Setup the Omnixie using the Omnixie Dashboard

## Display Setup

Set digits and LED backlight display effects.

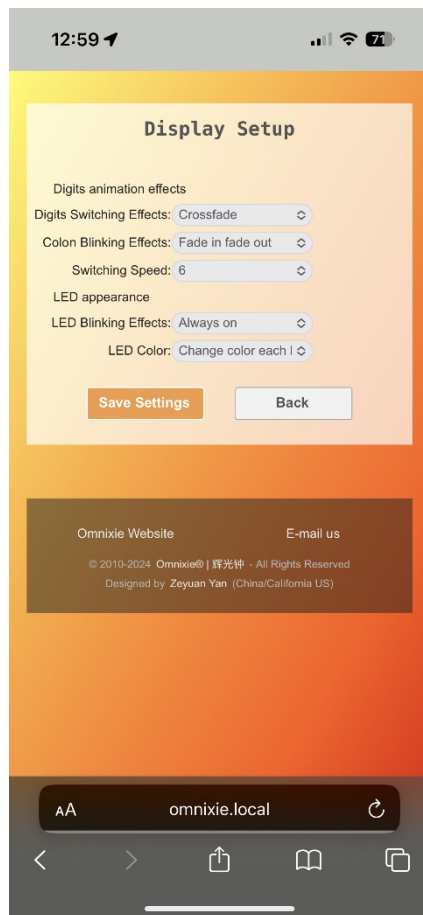

Name	Option	Description
Digits Switching Effects	Normal	
	Fade in fade out	
	Crossfade	Default
	Flip	
Colon Blinking Effects	Fade in fade out	Default
	Blink	
	Always on	
	Always off	
Switching Speed	0(Fastest) – 9(Slowest)	Default 6
LED Blinking Effects	Always off	
	Crossfade	
	Always on	Default
	Change color together	Default Change color each L->R
LED Color	Red, Orange, Green, Purple, Blue, Cyan, White	
	Change color each/all(L->R, R->L, Out->In, In->Out)	
	Rainbow days	Base-light color will following rainbow colors from Monday-Sunday



# Setup the Omnixie using the Omnixie Dashboard

## Setup Alarms

Setup alarms and automatic On/Off parameters.

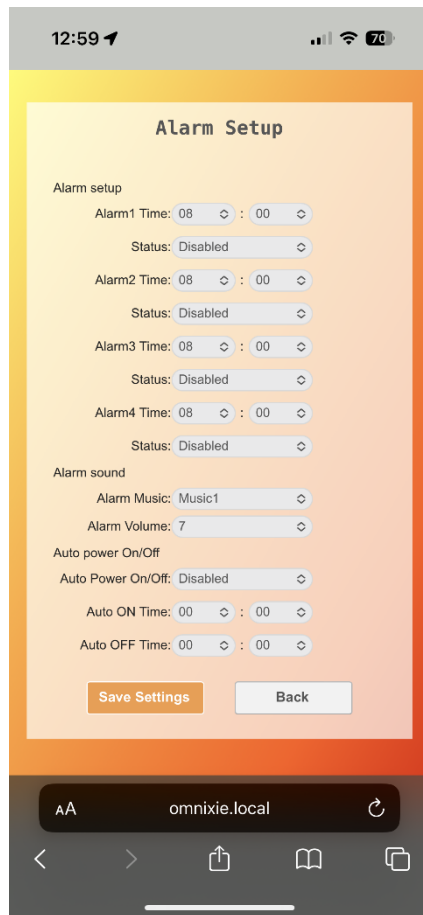

Name	Option	Description
Alarm 1/2/3/4 Time	Set Hour and Minute of Alarms	
Status	Disabled	Default
	Enabled (Only working days)	
	Enabled (All days)	
Alarm Music	Music 1 – Music 12	Default Music 1
Alarm Volume	1(Min) – 8(Max)	Default 7
Auto Power On/Off	Disabled	Default
	Enabled (Only working days)	
	Enabled (Everyday)	
Auto ON Time	Hour and Minute of Auto On	
Auto OFF Time	Hour and Minute of Auto Off	



- The working days means Monday – Friday.
- Alarm Volume is different with **General Setup** -> **Volume**.

# Setup the Omnixie using the Omnixie Dashboard

## Advanced Setup

Set relevant parameter of Nixie tube and default settings.

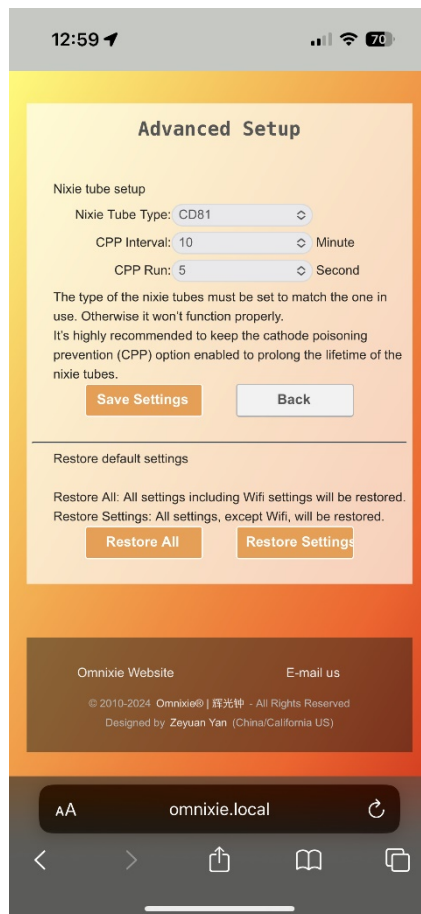

Name	Option	Description
Nixie Tube Type	Compatible Nixie tubes	Selected the correct Nixie tube type.
CPP interval	Interval of the cathode poisoning prevention. Default 10 Minutes	
CPP Run	Running time of the cathode poisoning prevention. Default 5 Seconds	
Restore all	Restore all settings including WiFi settings.	
Restore Settings	Restore all settings except WiFi settings.	



- Nixie tubes have an unwanted side effect called 'cathode poisoning' (CP) which causes metal molecules from the glowing cathodes (digits) and attach to non-glowing cathodes. This will cause deterioration and finally failure of the tube. To avoid this effect, non/seldom glowing cathodes need to be periodically switched on. Since cathode poisoning varies between different types of tubes, there is an adjustable cathode poisoning prevention setting.
- The cathode poisoning prevention function default settings are to run every 10 minutes for 5 seconds duration. The switch on of the non-glowing digits will be achieved by a fast sequential scrolling through the digits (slot machine effect). This feature can be adjusted in duration and frequency of scrolling.

# Setup the Omnixie using the Omnixie Dashboard

## Upgrade Firmware

The Omnixie firmware can be upgraded via browser.

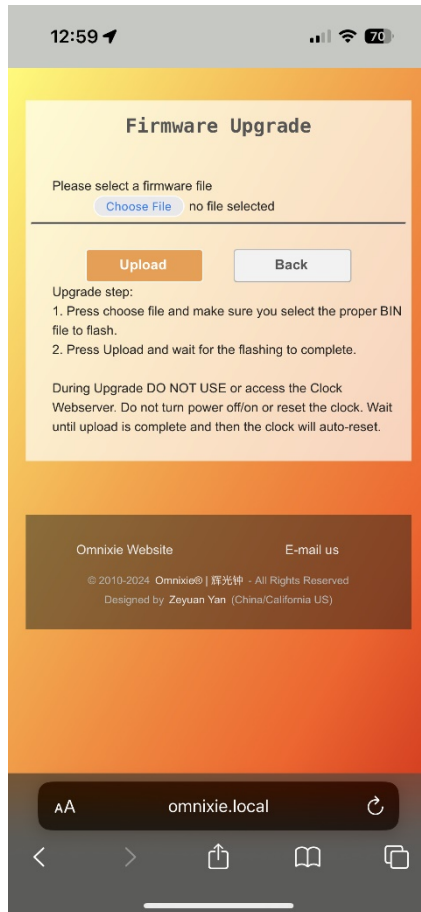

Upgrade steps:

1. Click the **Choose File** button to select the upgrade file, make sure the file is the Bin file used for upgrade.
2. Click the **Upload** button to start the upgrade and wait patiently for complete.



- Do NOT access the Dashboard page during the upgrade process, do NOT power off, the Omnixie will automatically restart after the upgrade is completed.
- Wifi network parameters need to reconfigure after upgrading.

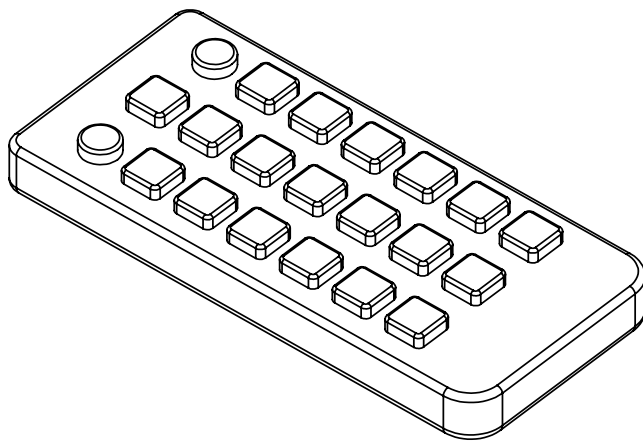

Setup the Omnixie with IR Remote

---

# IR remote

# Basic Operations

## Power On/Off

Toggle the Omnixie on/off by pressing **POWER** button on IR remote controller.

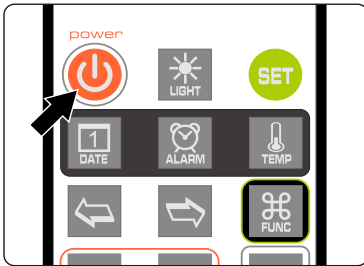

- Press **POWER** button of IR remote to power off.
- Press **POWER** button again to power on.



- With the Omnixie display off, the high voltage power to the tubes is completely removed for long tube life.
- During long periods of non-use, please disconnect the power.

## Set Brightness

Brightness of tubes and backlight can be set to eight levels or automatically adjusted according to ambient light conditions.

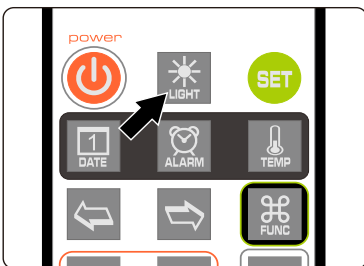

Level 1 (the darkest)



Level 2



Level 3

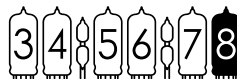

Level 8 (the brightest)

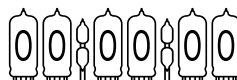

Automatic



- When brightness is set to automatic, the ambient light controls the brightness of tubes so that the clock will not disturb your sleep at night.
- The brightness of back light will be adjusted to the lowest brightness in automatic mode.

## Talking Clock

Internal phonetic chip can speak the clock time.



- Press **OK** button or **0-9** button to trigger talking clock.
- Set the time interval of automatic talking clock by following MENU 12.



- Talking clock can be triggered any time.
- Built-in speech system in English, Chinese Mandarin, Japanese and German. Speech system setup at MENU 11.
- Volume of talking clock is controlled by the system volume.

## Set Volume

Volume of talking clock or other sound effects can be set to eight levels.

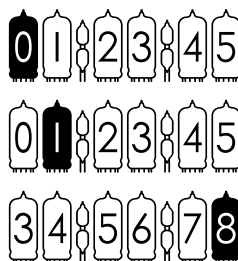
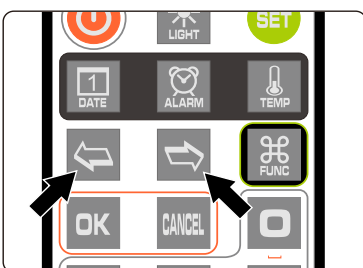

Mute

Minimum volume

Maximum volume

- Press **LEFT/RIGHT** button to set volume.



- This volume setting is only for talking clock and sound effect during operating. The volume of alarms is independent.
- To set volume of alarms please consult MENU 10.

## Display Time

- The Omnixie will display real time after power on.

E.g.: now time is PM 08:15:30, will display:

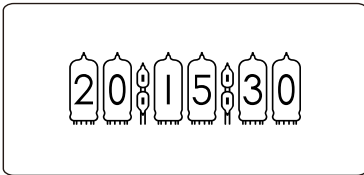

- Digits on the left are HOURS; digits in the middle are MINUTES; digits on right are SECONDS.

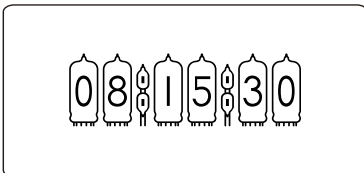

- Time will display as shown left when time format set to 12H.

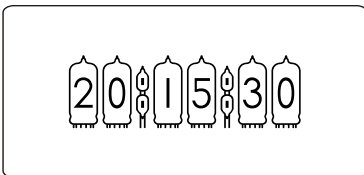

- Time will display as shown left when time format set to 24H.

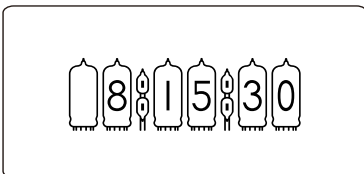

- Time will display as shown left when Leading Zero Disabled.

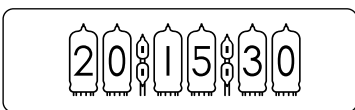

- Date will display for seconds with set interval.
- To set the interval, please consult MENU 3 and MENU 4.

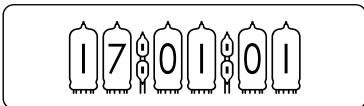

- To set 12/24 time format, please use MENU 1.
- To set leading zero, please use MENU 5.
- To control digital switching effect setting, please use MENU 6.
- To control digital switching speed setting, please use MENU 7.
- To set colon display effect, please use MENU 8.

## Set Time

Time can be set manually or synchronized from NTP server via WiFi.  
To set time manually:

- Press **SET** button enter time setting mode, 2 digits on the right start blinking.

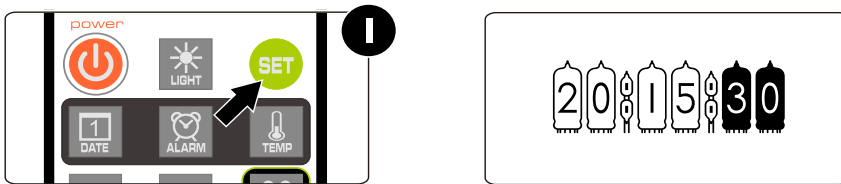

- Press **LEFT/RIGHT** button select position of setting.

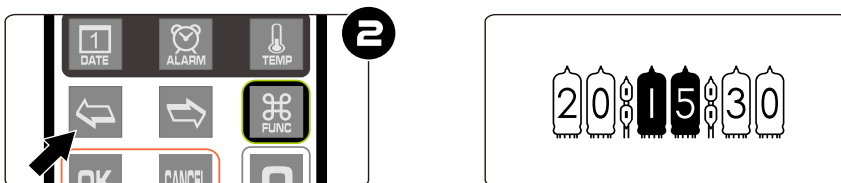

- Press **0-9** button input HOUR, MINUTE or SECOND.

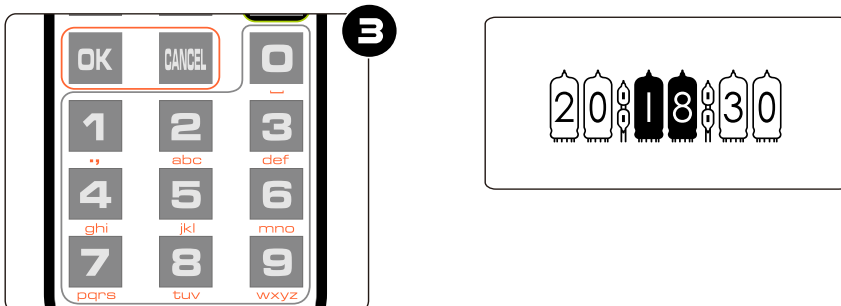

- Press **OK** button to save setting, press **CANCEL** button to abort.

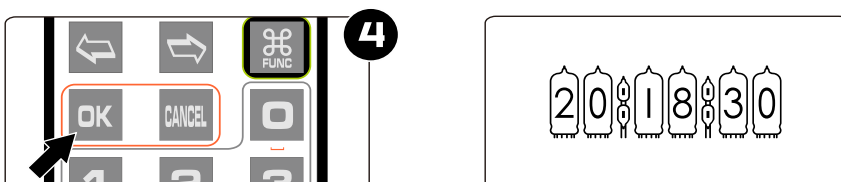

- Time will display in 24 hour mode HH:MM:SS during setting mode.
- Any digits can be input during setting, but system will check if the time entry is valid when you save it. Invalid times will not be saved.



## Display Date

Omnixie can display year, month, day and Chinese lunar date.

- Press **DATE** button once to display date; press twice to display Chinese lunar date.  
E.g.: Now date is Dec 1, 2016, Chinese lunar date is 2016-11-03.



- Press DATE button once, display date.

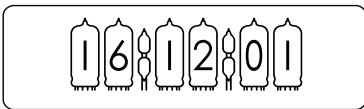

- Display date 2016-12-01, shown left.

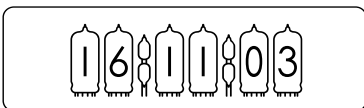

- Press DATE button twice, display Chinese lunar date 2016-11-03, shown left.

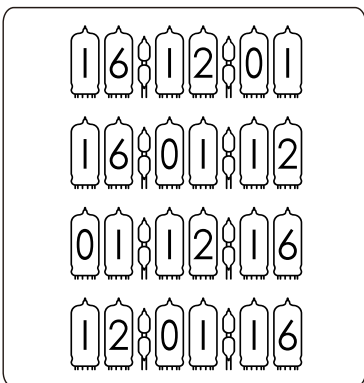

- Date format set to YY-MM-DD, shown left.
- Date format set to YY-DD-MM, shown left.
- Date format set to DD-MM-YY, shown left.
- Date format set to MM-DD-YY, shown left.



- After 3 seconds of display date, the Omnixie will return to time display mode.
- Date and time can be displayed alternately, please consult MENU 3 and MENU 4.
- Date format can show YY-MM-DD, YY-DD-MM, DD-MM-YY or MM-DD-YY, please consult MENU 2 to set the date format.

## Set Date

Date can be set manually or synchronized by NTP server via WiFi.  
To set date manually:

- Press **DATE** button to show the date.

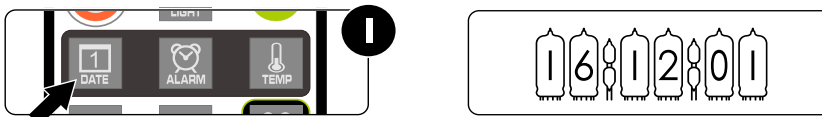

- Press **SET** button to enter set date mode, 2 digits on the left start blinking.



- Press **LEFT/RIGHT** button to select setting position.

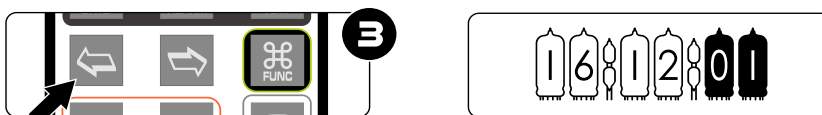

- Press **0-9** button to enter YEAR, MONTH or DAY.

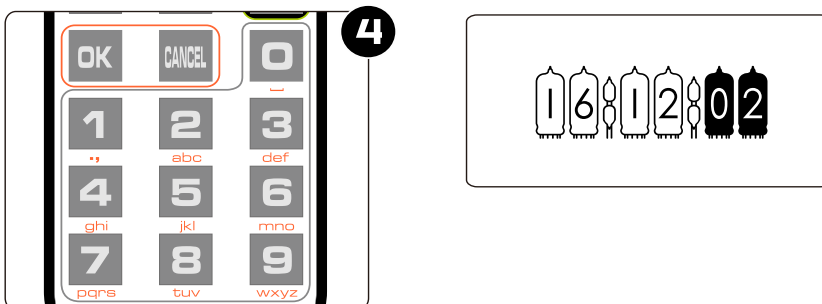

- Press **OK** button to save setting, press **CANCEL** to abort.

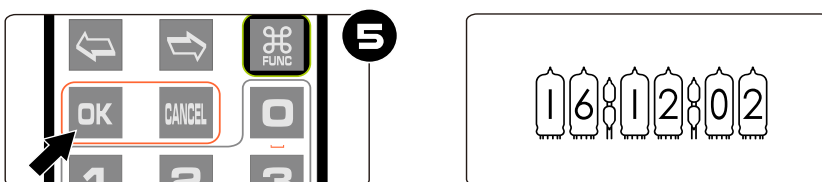

- In setting mode, the date format always displayed as YY-MM-DD.
- Any digits can be input during setting, but system will check if the date entry is valid when you save it. Invalid dates will not be saved.
- Chinese lunar date does not need to be set, the system will calculate it automatically.

## Display Alarms

The Omnixie can support 4 alarms, each can be active in working days or every day separately.

- Press **ALARM** button to check alarm 1, press twice/three times/four times to check alarm 2/3/4.

E.g.: Alarm 1 set to 7:00 AM.

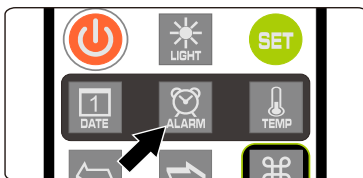

- Press **ALARM** button to display alarm 1 as shown left.

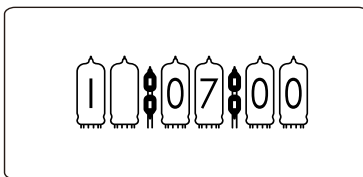

- Press **FUNC** button during display alarm to activate or disable alarm.

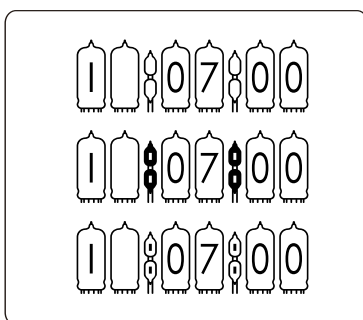

- Alarm disabled as shown left.
- Alarm activated in working days as shown left.
- Alarm activated every day as shown left.



- The Omnixie will return to time display mode from display alarm after 3 seconds.
- Alarm will sound for 60s.
- When the alarm sounds, you can press 0-9 button to snooze, the alarm will alarm again after 1-10 minutes (1-9 button for 1-9 minutes and 0 for 10 minutes), or press any other button to stop the alarm.

## Set Alarms

- Press **ALARM** button to select alarm, digits on the left will show alarm number, 1 means alarm 1, 2 is alarm 2.

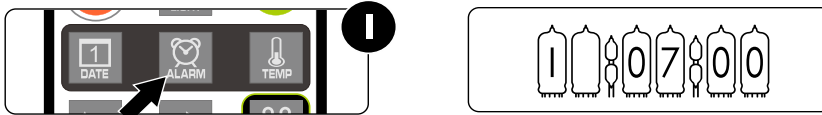

- Press **SET** button to enter alarm set mode, HOUR blinks during setting.

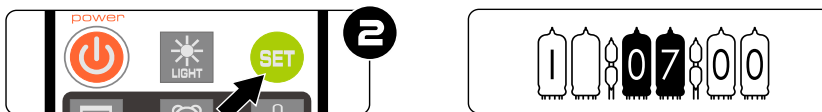

- Press **LEFT/RIGHT** button to select set position.

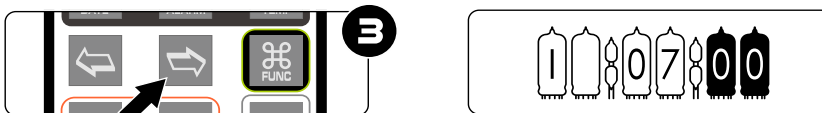

- Press **0-9** button to input HOUR or MINUTE.

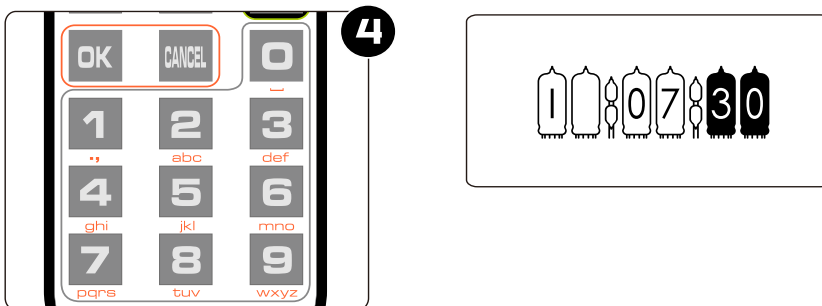

- Press **OK** button to save setting, press **CANCEL** to abort.

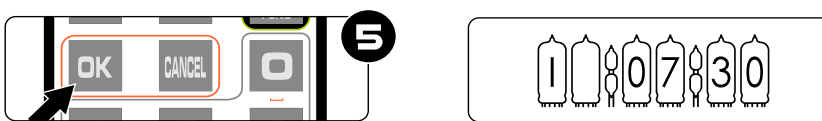

- Any digits can be input during setting, but system will check if the alarm time entry is valid when you save it. Invalid alarm times will not be saved.
- Consult DISPLAY ALARMS for information on how to enable/disable alarm.

## Set Auto On/Off time

Press **ALARM** button 5 times to display AUTO ON time, press 6 times to display AUTO OFF time. Colon blinking means active on working days, colon always on means active every day, colon does not light up means disabled.

E.g.: AUTO ON time set to 8:00 AM, AUTO OFF time set to 10:00 PM.

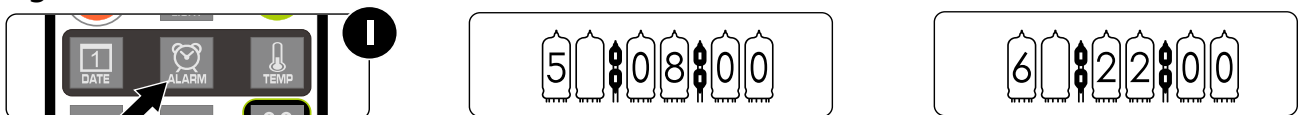

- Press SET button to enter auto on/off time setting mode, HOUR blinks.



- Press LEFT/RIGHT button to select setting position.

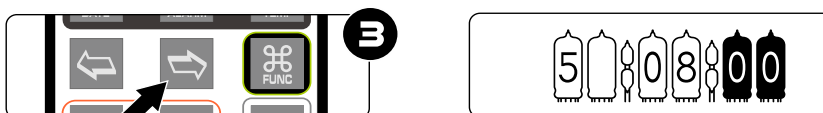

- Press 0-9 to input HOUR or MINUTE.

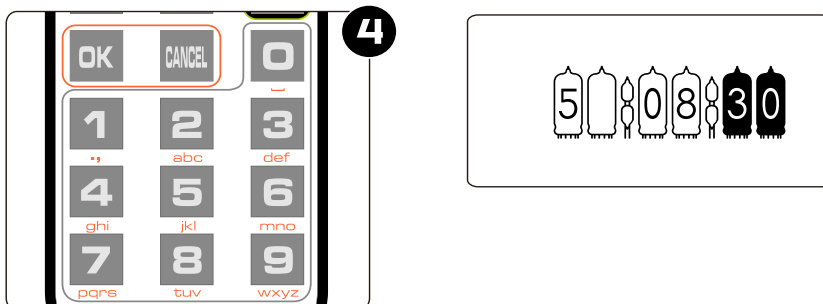

- Press OK button to save setting, press CANCEL to abort.

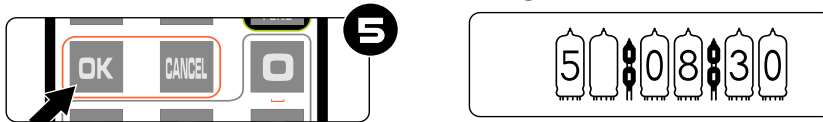

- Any digits can be input during setting, but system will check if the time entry is valid when you save it. Invalid times will not be saved.
- The Omnixie default will check auto on/off mode and time every minute.

## System Menu

There are 17 different items in the menu for setting system parameter.



- Press **FUNC** button to enter menu.

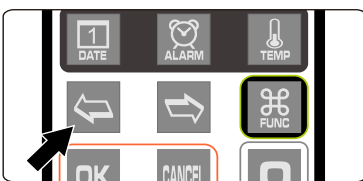

- Press **LEFT/RIGHT** to select menu items.
- Press **SET** button to set current menu item.



- The Omnixie will return to time display mode after 3 minutes if there are no menu operations.

## Menu Setup

There are 17 items in the menu to set parameters.



- Press **SET** button to enter setting mode.



- Press **LEFT/RIGHT** button to change setting position.

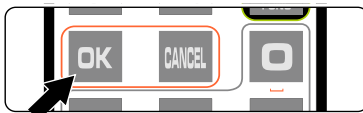

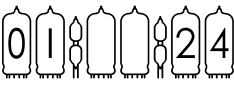
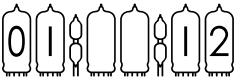

- Press **OK** to save setting.
- Press **CANCEL** to abort.

## Menu 1 Set Time Format

Display	Parameter	Remarks
	24 hour	Default
	12 hour	

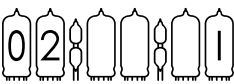
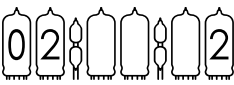
## Menu 2 Set Date Format

Display	Parameter	Remarks
	YY-MM-DD	Default
	YY-DD-MM	
	DD-MM-YY	
	MM-DD-YY	



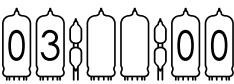
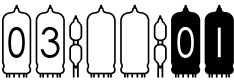
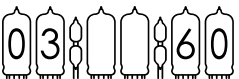

## Menu 3 Set Interval of Time Display

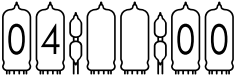
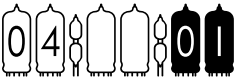
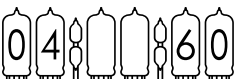
Display	Parameter	Remarks
	0 second	Default
	0 - 60 seconds	
	60 seconds	



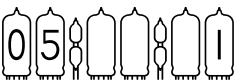

## Menu 4 Set Interval of Date Display

Display	Parameter	Remarks
	0 second	Default
	0 - 60 seconds	
	60 seconds	

## Menu 5 Set Leading Zero

Display	Parameter	Remarks
	On E.g.: 	Default
	Off E.g.: 	

## Menu 6 Set Switching Effects of the Digits





Display	Parameter	Remarks
	Normal	
	Fade in-out	
	Cross-fading	Default
	Slot machine	

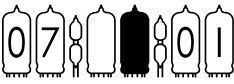
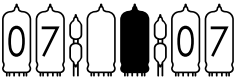
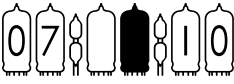

## Menu 7 Set Switching Speed of the Digits

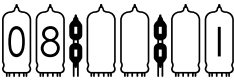
Display	Parameter	Remarks
	01 Fastest	
	01-10 10 level in total	Default 07
	10 Slowest	

## Menu 8 Set Colons Animation Effects

Display	Parameter	Remarks
	Fade in-out	Default
	Blinking	
	Always on	
	Always off	

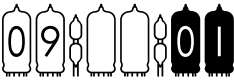

## Menu 9 Set Alarm Sound Tone

Display	Parameter	Remarks
	No.01 to No.12	Default No.01

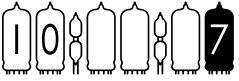

## Menu 10 Set Alarm Volume

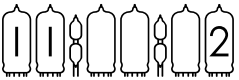
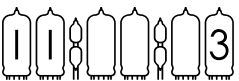
Display	Parameter	Remarks
	Level 1 (Min) to 8 (Max)	Default 7



## Menu 11 Set Talking Clock Language

Display	Parameter	Remarks
	Chinese Mandarin	Default
	English	
	Japanese	
	German	

## Menu 12 Set Interval of Talking Clock

Display	Parameter	Remarks
	Talking clock disabled	
	0,1,2,3,5,10,15,20,30,60 Minutes	
	60 Minutes	Default

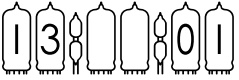
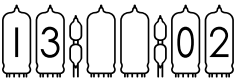

## Menu 13 Set Backlight Effects

Display	Parameter	Remarks
	Backlight disabled	
	Fade in-out	
	Always on	Default

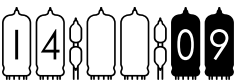
## Menu 14 Set Backlight Color

Display	Parameter	Remarks
	No.01-No.15 (Preview when setting)	Default 09

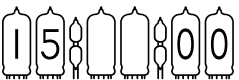
## Menu 15 Set Interval of CP prevention

Display	Parameter	Remarks
	CP disabled	Not recommended
	0,1,2,3,5,10,15,20,30,60 Minutes	
	Max 60 Minutes	Default 10 Mins

 ■ Nixie tubes have an unwanted side effect called 'cathode poisoning' (CP) which causes metal molecules from the glowing cathodes (digits) and attach to non-glowing cathodes. This will cause deterioration and finally failure of the tube. To avoid this effect, non/seldom glowing cathodes need to be periodically switched on. Since cathode poisoning varies between different types of tubes, there is an adjustable cathode poisoning prevention setting.

## Menu Setup

Menu 16 

Set Running Time of CP Prevention

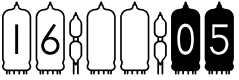
Display	Parameter	Remarks
	05-30 Seconds	Default 5 Seconds

Menu 17 

Display IP Address

Display	Parameter	Remarks
	IP address	

Menu 18 

Display Firmware Version

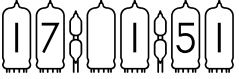
Display	Parameter	Remarks
	v1.5.1	

## Special Remarks

- These Nixie Tubes were produced between 1960 to 1980, and there may be some differences between tubes and manufacturing lots. This is normal, and will not have any effect on the tube operation.
- The Omnixie will become warm or little hot during operation due to the internal DC-DC converter circuitry. This is normal operation and no cause for concern.
- The bottom plate of the Omnixie is made from stainless steel and is heavy. Please take care not to drag the unit by the cable to avoid damage to the power socket.